

**BM4200N**  
**BM4200N-2**

# Video Baby Monitor



## **User Guide**

This guide contains important information.  
Please keep it for future reference.

# Contents

<b>Important Safety Instructions</b> .....	<b>3</b>
<b>Setup</b> .....	<b>4</b>
What's Included? .....	4
Overview .....	5
Parent Unit Icons.....	9
Connect the Baby Monitor .....	13
Charge the Parent Unit Battery.....	14
Position the Baby Monitor .....	15
<b>Basic Operation</b> .....	<b>16</b>
Power on/off.....	16
StatusCheck.....	23
Use the Menu .....	17
Adjust Speaker Volume .....	18
Talk to Your Baby via the Baby Unit.....	18
Zoom.....	19
Turn on/off the Parent Unit Screen .....	19
<b>Advanced Operation</b> .....	<b>20</b>
Adjust Screen Brightness .....	20
Lullabies and Soothing Sounds .....	20
Night Light.....	21
Sound Sensitivity and Sound Activation .....	22
Temperature.....	24
Turn on/off Alert Tones .....	25
Adjust Baby Unit Speaker Volume .....	26
Dim Mode .....	27
Night Vision.....	27
Monitoring Modes (BM4200N-2 only).....	28
<b>Additional Information</b> .....	<b>30</b>
Wall Mount (Optional) .....	30
General Product Care.....	33
Storage .....	33
Technical Specifications.....	33
Customer Service and Product Warranty .....	34
Disposal of Batteries and Product .....	35

# Important safety instructions

The applied nameplate is located at the bottom of the baby unit's base.

When using your equipment, basic safety precautions should always be followed to reduce the risk of fire, electric shock and injury, including the following:

1. Follow all warnings and instructions marked on the product.
2. Adult setup is required.
3. **CAUTION:** Do not install the baby unit at a height above 2 metres.
4. This product is not a substitute for adult supervision of the infant. Supervising the infant is the parent's or caregiver's responsibility. This product could cease operating, and therefore you should not assume it will continue working properly for any given period of time. Further, this is not a medical device and should not be used as such. This product is intended to assist you in supervising your baby.
5. Do not use this product near water. For example, do not use it next to a bath tub, wash bowl, kitchen sink, laundry tub or swimming pool, or in a wet basement or shower.
6. **CAUTION:** Use only the battery provided. There may be a risk of explosion if a wrong type of battery is used for the parent unit. The battery cannot be subjected to high or low extreme temperature and low air pressure at high altitude during use, storage or transportation. Disposal of battery into fire or a hot oven, or mechanically crushing or cutting or the battery can result in an explosion. Leaving the battery in an extremely high temperature surrounding environment can result in an explosion or the leakage of flammable liquid or gas. Battery subjected to extremely low air pressure may result in an explosion or the leakage of flammable liquid or gas. Dispose of used battery according to the instructions.
7. Use only the adapters included with this product. Incorrect adapter polarity or voltage can seriously damage the product.



#### Power adapter information:

Baby unit power adapter: Output: 5V DC 600mA;  
VTech Telecommunications Ltd. Model: VT05EAU05060  
Parent unit power adapter: Output: 5V DC 1A.  
VTech Telecommunications Ltd. Model: VT05EAU05100



#### Rechargeable battery information:

3.6V 2600mAh, 9.36Wh Lithium-ion battery  
Zhuhai Great Power Energy Co., Ltd.  
Model: ICR18650-2.6Ah-3.6V-1S1P

8. The power adapters are intended to be correctly oriented in a vertical or floor mount position. The prongs are not designed to hold the plug in place if it is plugged into a ceiling, under-the-table or cabinet outlet.
9. For pluggable equipment, the socket-outlet shall be installed near the equipment and shall be easily accessible.
10. Unplug this product from the wall outlet before cleaning. Do not use liquid or aerosol cleaners. Use a damp cloth for cleaning.
11. Do not cut off the power adapters to replace them with other plugs, as this causes a hazardous situation.
12. Do not allow anything to rest on the power cords. Do not install this product where the cords may be walked on or crimped.
13. This product should be operated only from the type of power source indicated on the marking label. If you are not sure of the type of power supply in your home, consult your dealer or local power company.
14. Do not overload wall outlets or use an extension cord.
15. Do not place this product on an unstable table, shelf, stand or other unstable surfaces.
16. This product should not be placed in any area where proper ventilation is not provided. Slots and openings in the back or bottom of this product are provided for ventilation. To protect them from overheating, these openings must not be blocked by placing the product on a soft surface such as a bed, sofa or rug. This product should never be placed near or over a radiator or heat register.

17. Never push objects of any kind into this product through the slots because they may touch dangerous voltage points or create a short circuit. Never spill liquid of any kind on the product.
18. To reduce the risk of electric shock, do not disassemble this product, but take it to an authorized service facility. Opening or removing parts of the product other than specified access doors may expose you to dangerous voltages or other risks. Incorrect reassembling can cause electric shock when the product is subsequently used.
19. You should test the sound reception every time you turn on the units or move one of the components.
20. Periodically examine all components for damage.
21. There is a very low risk of privacy loss when using certain electronic devices, such as baby monitors, cordless telephones, etc. To protect your privacy, make sure the product has never been used before purchase, reset the baby monitor periodically by powering off and then powering on the units, and power off the baby monitor if you will not use it for some time.
22. Children should be supervised to ensure that they do not play with the product.
23. The product is not intended for use by persons (including children) with reduced physical, sensory or mental capabilities, or lack of experience and knowledge, unless they have been given supervision or instruction concerning use of the appliance by a person responsible for their safety.

## SAVE THESE INSTRUCTIONS

### Cautions

1. Use and store the product at a temperature between 0°C and 40°C.
2. Do not expose the product to extreme cold, heat or direct sunlight. Do not put the product close to a heating source.
3. Batteries should not be exposed to excessive heat such as bright sunshine or fire.
4. Make sure the baby unit(s) and the adapter cord(s) are always out of reach of the baby, at least 3 feet away from the baby or cot, to avoid a possible strangulation hazard.
5. Never place the baby unit(s) inside the baby's cot or playpen. Never cover the baby unit(s) or parent unit with anything such as a towel or a blanket.
6. Other electronic products may cause interference with your baby monitor. Try installing your baby monitor as far away from these electronic devices as possible: wireless routers, radios, cellular telephones, intercoms, room monitors, televisions, personal computers, kitchen appliances and cordless telephones.



### Precautions for users of implanted cardiac pacemakers

Cardiac pacemakers (applies only to digital cordless devices):

Wireless Technology Research, LLC (WTR), an independent research entity, led a multidisciplinary evaluation of the interference between portable wireless devices and implanted cardiac pacemakers. Supported by the U.S. Food and Drug Administration, WTR recommends to physicians that:

#### Pacemaker patients

- Should keep wireless devices at least six inches from the pacemaker.
- Should NOT place wireless devices directly over the pacemaker, such as in a breast pocket, when it is turned ON.

WTR's evaluation did not identify any risk to bystanders with pacemakers from other persons using wireless devices.

#### Electromagnetic fields (EMF)

This VTech product complies with all standards regarding electromagnetic fields (EMF). If handled properly and according to the instructions in this user's manual, the product is safe to be used based on scientific evidence available today.

# Setup

## What's Included?

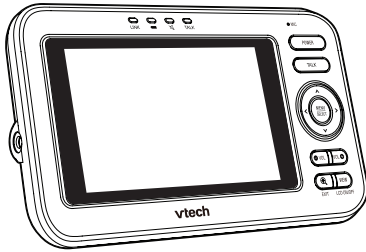

**Parent Unit**

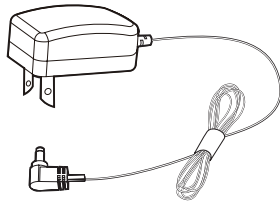

**Parent Unit Adapter**



Learn to set up your units and have all detailed instructions on using your baby monitor.

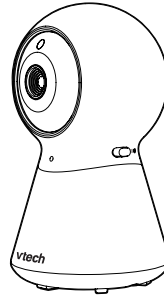

**Baby Unit**

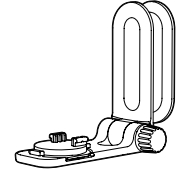

**Wall Mount Bracket**

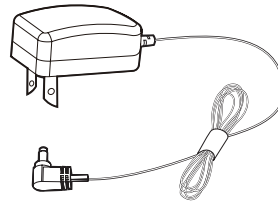

**Baby Unit Adapter**



x 2



x 2

1 set for BM4200N  
2 sets for BM4200N-2



# Overview

## Baby Unit

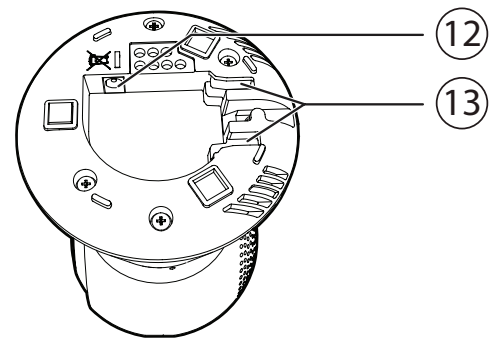
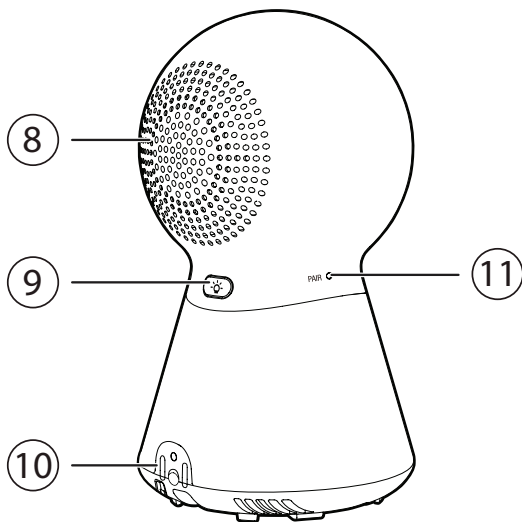
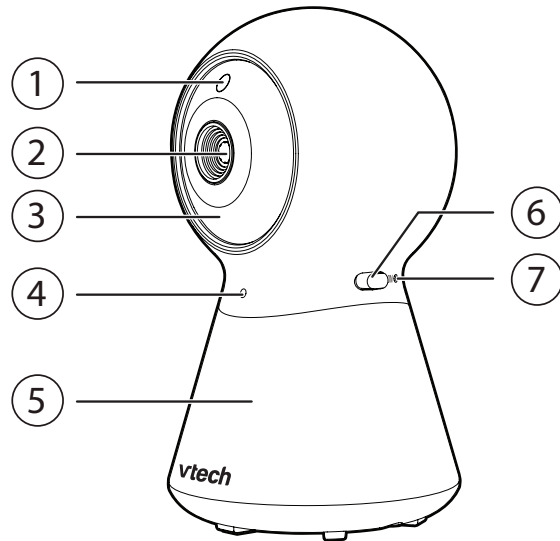





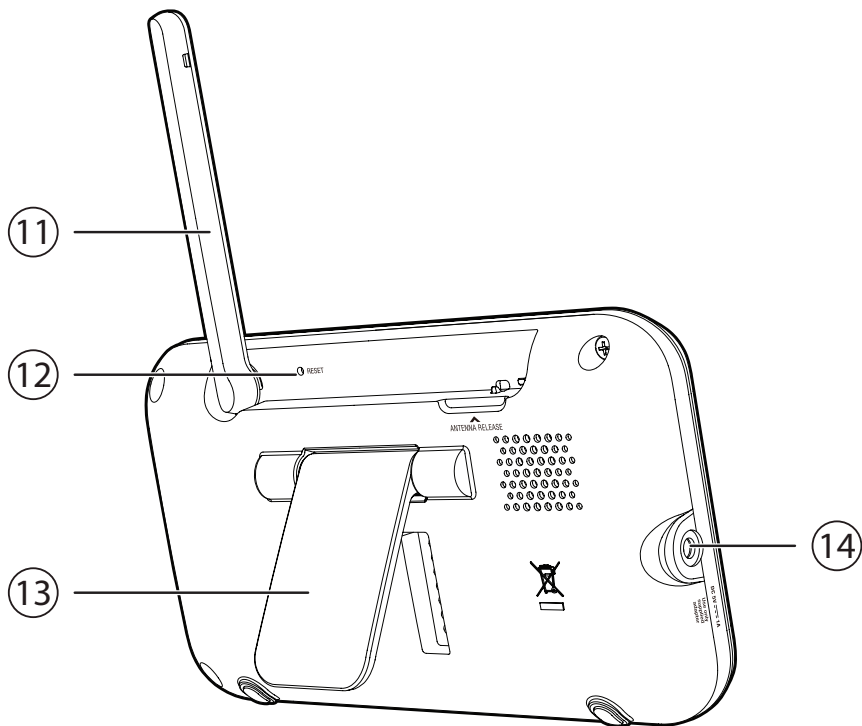
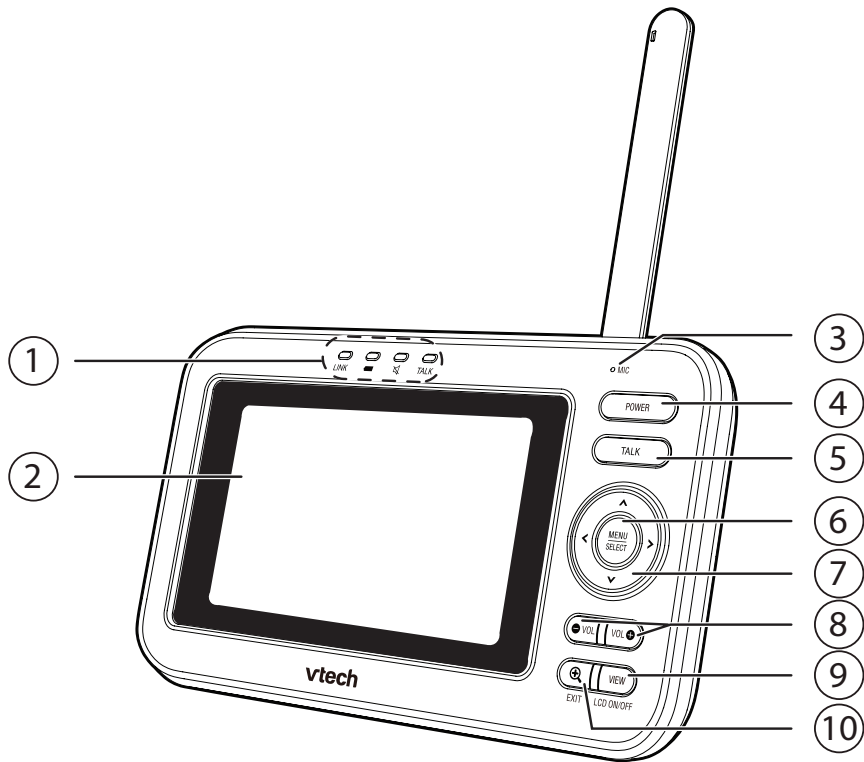



















<b>1</b>	<b>Light sensor</b>
<b>2</b>	<b>Camera</b>
<b>3</b>	<b>Gloss lens</b>
<b>4</b>	<b>Microphone</b>
<b>5</b>	<b>Night light</b>
<b>6</b>	<b>On/Off switch</b>
<b>7</b>	<b>On/Off LED light</b> <ul style="list-style-type: none"> <li>• On when the baby unit is turned on and is paired to the parent unit.</li> <li>• Flashes when the baby unit is not being viewed; or when the link to the parent unit is lost.</li> </ul>
<b>8</b>	<b>Speaker</b>
<b>9</b>	 <b>Night light on/off key</b>
<b>10</b>	<b>Temperature sensor</b>
<b>11</b>	<b>Pair key</b>
<b>12</b>	<b>Power jack</b>
<b>13</b>	<b>Slots for wall mounting</b>

# Parent Unit



1	<b>LED lights</b>
2	<b>LCD display</b>
3	<b>Microphone</b>
4	<b>POWER</b>
5	<b>TALK</b>
6	<b>MENU/SELECT</b>
7	<b>Arrow keys</b> <ul style="list-style-type: none"> <li>• Press to navigate leftward, upward, rightward or downward, within the main menu and sub-menus.</li> <li>• While viewing a zoomed image, press to move the image leftward, upward, rightward or downward.</li> </ul>
8	<b>⊖ Volume ⊕</b>
9	<b>VIEW /LCD ON/OFF</b>
10	<b>⊕ /EXIT</b>
11	<b>Antenna</b>
12	<b>RESET</b>
13	<b>Stand</b>
14	<b>Power jack</b>

# Parent unit icons

Main menu	Sub-menu		
<b>Brightness</b>			
			<ul style="list-style-type: none"> <li>Adjust the parent unit's LCD brightness.</li> </ul>
<b>Camera settings</b>			
			<b>Baby unit speaker volume</b> <ul style="list-style-type: none"> <li>Adjust the baby unit's speaker volume.</li> </ul>
		<b>Monitoring mode (For BM4200N-2 only)</b>	
			<ul style="list-style-type: none"> <li>Single mode</li> </ul>
			<ul style="list-style-type: none"> <li>Split mode</li> </ul>
			<ul style="list-style-type: none"> <li>Patrol mode</li> </ul>
<b>Lullaby</b>			
		<b>Play/Stop lullaby</b>	
			<ul style="list-style-type: none"> <li>Select one of the soothing sounds, or white noise.</li> </ul>
			<ul style="list-style-type: none"> <li>Select one of the five melodies.</li> </ul>
		<ul style="list-style-type: none"> <li>Play all melodies.</li> </ul>	
	<b>60min 45min 30min 15min OFF</b> <ul style="list-style-type: none"> <li>Set timer to stop playing the selected melody or soothing sound.</li> </ul>		
<b>Night light</b>			
	<b>ON / OFF</b>	<b>Turn on/off night light</b>	
			<ul style="list-style-type: none"> <li>Select one of the night light colors.</li> </ul>
		<ul style="list-style-type: none"> <li>Change to all seven colors in cycles.</li> </ul>	
	<b>60min 45min 30min 15min OFF</b> <ul style="list-style-type: none"> <li>Set timer to turn the night light off.</li> </ul>		
	<b>AUTO</b> <ul style="list-style-type: none"> <li>Set to auto turn on the night light when baby unit detects sound. It will turn off after 15 minutes of no sound detection. You can set <b>VOX sensitivity level</b> to detect sounds that exceed certain levels. See <b>Sound sensitivity and sound activation</b> section.</li> </ul>		
	<b>ON / OFF</b> <ul style="list-style-type: none"> <li>Turn on/off the adaptive night light feature. When this feature is on, the baby unit detects the ambience light. If the room is bright, the night light adjusts itself to be brighter; if the room is dim, the night light adjusts itself to be less bright.</li> </ul>		

Main menu	Sub-menu		
<b>Alert settings</b>			
			• Set the parent unit to beep when the battery is low.
			• Set the parent unit to beep when the link between the parent unit and the baby unit is lost.
			• Set the confirmation tone on or off when selecting an option in the menus.
			• Set the parent unit to beep when the baby unit detects sounds while in <b>Split mode</b> (For <b>BM4200N-2</b> only).
<b>Temperature</b>			
		<b>ON / OFF</b>	<ul style="list-style-type: none"> <li>• Turn on/off temperature alert tone.</li> <li>• Set the parent unit to beeps whenever the room temperature detected by the baby unit falls outside of the set temperature range.</li> </ul>
			• Set the minimum temperature.
			• Set the maximum temperature.
		<b>°F °C</b>	• Set temperature display in Fahrenheit (°F) or Celsius (°C)
		<b>Sound activation - screen and audio</b>	
	<b>ON / OFF</b>	<b>Turn on/off sound activation</b>	
		<ul style="list-style-type: none"> <li>• Set sound activation on or off.</li> <li>• When it is on, and the baby unit detects no sound, the parent unit screen stays off to save power. Once a sound is detected, the parent unit screen and speaker turns on automatically, and you can see and hear your baby. The parent unit will then turn off again after 50 seconds of no sound detection.</li> </ul> <p><b>Note</b></p> <ul style="list-style-type: none"> <li>• When the parent unit screen is off and it receives alerts, for example, link lost between parent unit and baby unit, or battery is low, the parent unit screen and speaker will turn on for 10 seconds.</li> </ul>	
<b>VOX (Voice Activated Alert) Sensitivity</b>			
		<ul style="list-style-type: none"> <li>• You can set VOX sensitivity level to activate parent unit screen and sound when baby unit detects sounds that exceed certain levels. See <b>Sound sensitivity and sound activation</b> section.</li> </ul>	



## Status icons



### Connection status

- - Strong signal strength.
- - Moderate signal strength.
- - Low signal strength.
- - Weak signal strength.



### Split mode

(\*For BM4200N-2 only)



### Patrol mode

(\*For BM4200N-2 only)



or



### Current view status

- The baby unit number that is being viewed when in:
  - Single CAM mode.
  - Patrol mode (\*For BM4200N-2 only)
  - Split mode (\*For BM4200N-2 only)



### Night vision - On



### Zoom - On



### Lullaby - On













### Night light - On







### Night light - Auto-on

- Color icon indicates the night light is set to auto-on, and is currently turned on by sound activation.
- Gray icon indicates the night light is currently off but is set to auto-on. Night light will turn on when sound is detected by the baby unit.

## Status icons

<p>°F or °C</p>	<p><b>Real-time temperature</b></p> <ul style="list-style-type: none"> <li>• Real-time temperature detected by the baby unit in Fahrenheit (°F) or Celsius (°C) (e.g. <b>57°F</b> or <b>14°C</b>).</li> </ul>
	<p><b>Temperature alert tone - On</b></p>
	<p><b>9-level sound indicator</b></p> <ul style="list-style-type: none"> <li>•  indicates low sound level detected by the baby unit.</li> <li>•  indicates moderate sound level detected by the baby unit.</li> <li>•  indicates high sound level detected by the baby unit.</li> </ul>
	<p><b>Mute alert</b></p> <ul style="list-style-type: none"> <li>• Displays when the parent unit speaker volume is set to off.</li> <li>• Displays when the parent unit is talking to the baby unit.</li> </ul>
	<p><b>Battery status</b></p> <ul style="list-style-type: none"> <li>•  animates when the battery is charging.</li> <li>•  - battery is fully charged.</li> <li>•  - battery is low and needs charging.</li> </ul>
	<p><b>Speaker volume</b> - displays the parent unit speaker volume level while adjusting.</p>

## Alert icons

	<ul style="list-style-type: none"> <li>• Displays when parent unit's battery is low and needs charging.</li> </ul>
	<ul style="list-style-type: none"> <li>• Displays when connection between parent unit and baby unit is lost.</li> </ul>
	<ul style="list-style-type: none"> <li>• Displays when sound is detected at a baby unit when in <b>Split</b> view. (*For <b>BM4200N-2</b> only)</li> </ul>
	<ul style="list-style-type: none"> <li>• Baby unit detects temperature reaches or exceeds the set maximum.</li> </ul>
	<ul style="list-style-type: none"> <li>• Baby unit detects temperature is at or is lower than the set minimum.</li> </ul>

# Connect the Baby Monitor

Connect the parent unit and baby unit to a power supply with the included power adapters.

## Notes:

- The rechargeable battery in the parent unit is built-in.
- Use only the power adapters supplied with this product.
- Make sure the baby monitor is not connected to a switch-controlled electric outlet.
- Connect the power adapters in a vertical or floor mount position only. The adapters' prongs are not designed to hold the weight of baby monitor, so do not connect them to any ceiling, under-the-table, or cabinet outlets. Otherwise, the adapters may not properly connect to the outlets.
- Make sure the parent unit, the baby units and the power adapter cords are out of reach of children.

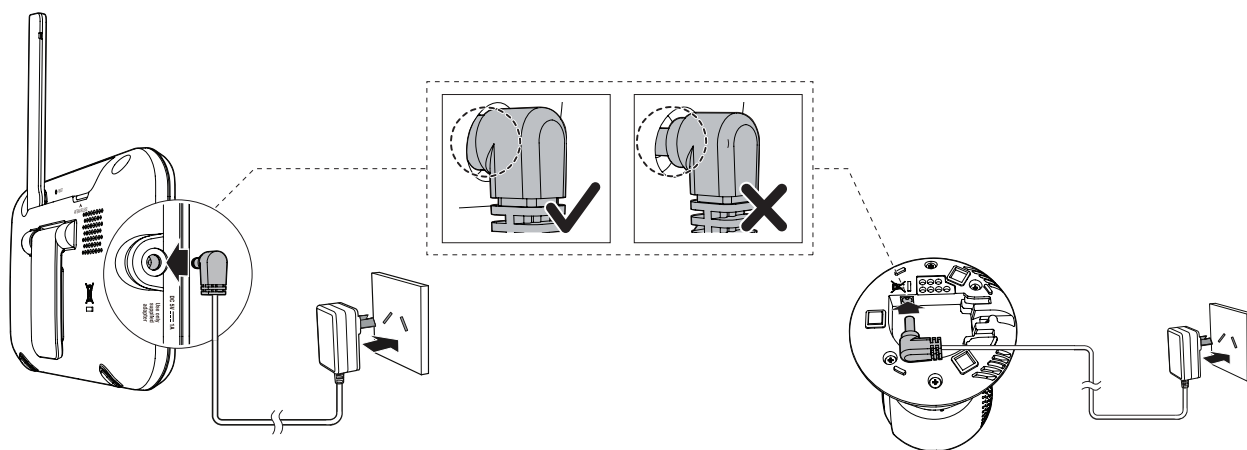

# Charge the Parent Unit Battery





The parent unit runs on rechargeable battery or AC power. To continuously monitor your baby, keep the parent unit connected to AC power.

The parent unit turns on automatically after it connects to the power socket for the first time using, and its battery will charge at the same time.

## Notes:

- Before using the baby monitor for the first time, charge the parent unit battery for 12 hours. When the parent unit battery is fully charged, the battery icon becomes solid .
- The standby time varies depending on your actual use.

The battery icon on the screen indicates the battery status (see the following table).

Battery Indicators	Battery Status	Action
The screen displays  or  . The  LED light flashes.	The battery power is very low and may only be used for a short time.	Charge without interruption (about 30 minutes).
The battery icon becomes solid  .	The battery is fully charged.	To keep the battery charged, connect it to AC power when in use.

# Positioning the Baby Monitor

**Caution:** Keep the baby unit out of the reach of your baby. Never place or mount the baby unit inside the baby's crib or playpen.

1. Place the baby unit more than 3 feet (1m) away from your baby.
2. Manually tilt the camera angle up and down by pushing the lens portion upwards and downwards to aim at your baby.

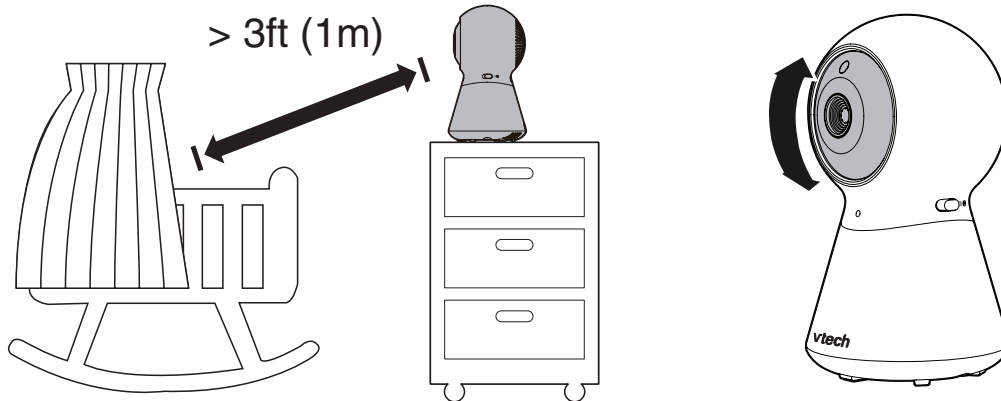

## ⓘ CAUTION

- The default volume of your parent unit is level 4, and the maximum volume is level 7. If you experience high-pitched screeching noise from your baby monitor while positioning:
  - Make sure your baby unit and parent unit are more than 1 metre apart, OR
  - Lower the volume of your parent unit.

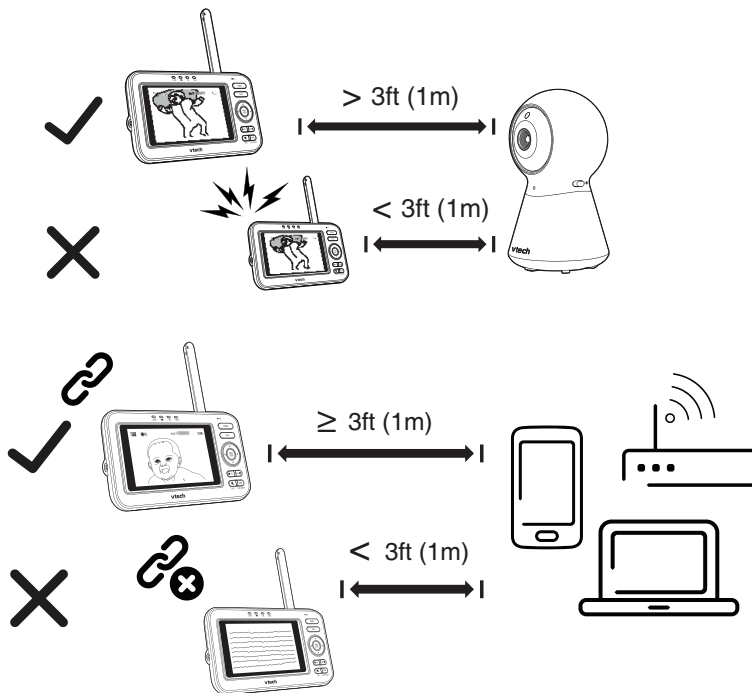

## Note:

- To avoid interference from other electronic devices, place your baby monitor at least 1 metre away from devices such as wireless routers, microwaves, cell phones and computers.

# Basic Operation

## Power on/off

1. Slide the switch to power on or off your baby unit.

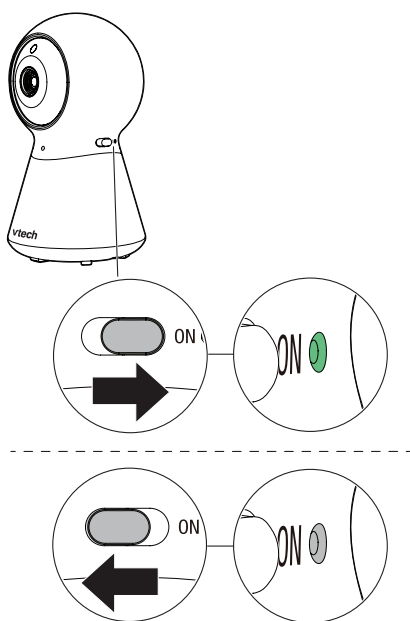

2. Press and hold **POWER** to power on or off your parent unit.



**Power on**



**Power off**



# Status Check

Once you power on both your baby unit and parent unit, your parent unit displays image from the baby unit, and the **LINK** LED light turns on.

The **ON** LED light of baby unit turns on.

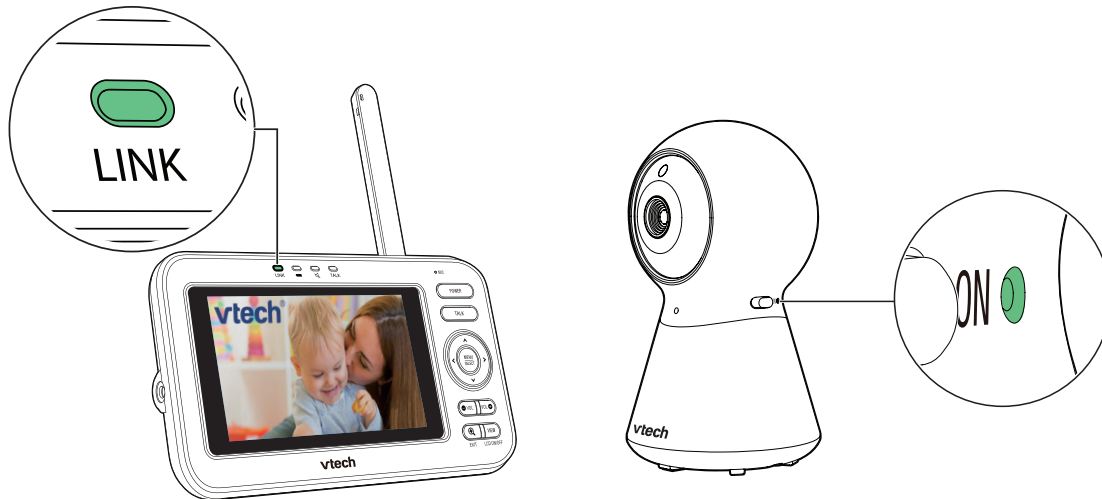

## Use the menu

Press **MENU SELECT** to enter the menu, choose a menu item, or save a setting. You can use the parent unit for advanced settings or operations, such as to play or stop the baby unit lullaby, or to adjust the baby unit sound sensitivity.

While in the menu:

- Press **<** or **>** to scroll among the menu options.
- Press **MENU SELECT** to select an item, or to save a setting.
- Press **▲** or **▼** to scroll among the sub-menus, or to adjust a setting.
- Press **<** to return to the previous menu options without changing the current setting.
- Press **Ⓚ** /EXIT to return to live video.

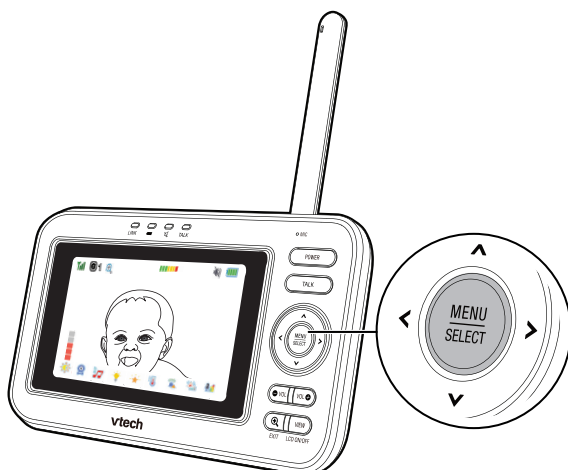

# Adjust Speaker Volume

Press **⊖ VOL / VOL ⊕** to adjust your parent unit speaker volume.



# Talk to your baby unit

Press and hold TALK and speak to your parent unit. Your voice is transmitted to the baby unit. Release TALK when finish talking and hear your baby again.

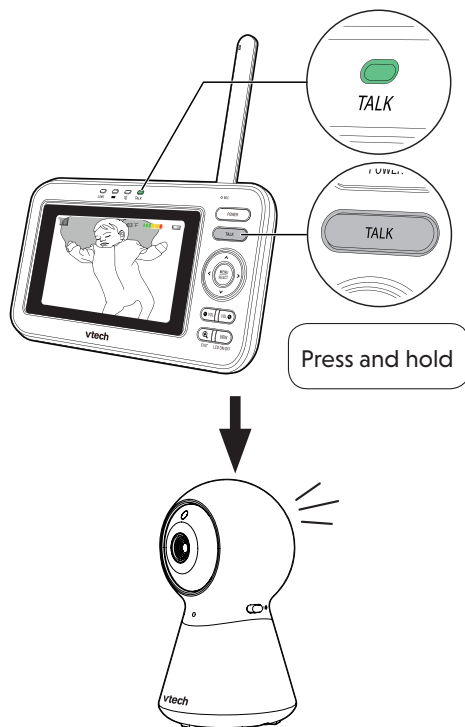

# ZOOM

Press  to zoom in or out.



# Turn off the screen

Press and hold **LCD ON/OFF** to switch off the screen. You can still hear sound from the baby unit.



## Tip







- Press any keys on the parent unit to turn on the screen again.

# Advanced Operation

## Adjust Screen Brightness

You can change the brightness of the parent unit screen from Level 1 to Level 5. The LCD screen brightness is preset to Level 3.











































**To adjust LCD brightness:**

1. Press   on the parent unit to select  (**Brightness**).
2. Press  to increase or press  to decrease the brightness, then press   to confirm your setting.

## Lullabies and Soothing Sounds

There are 5 lullabies and 4 soothing sounds in the baby monitor for you to comfort your baby with.

### Play the Lullabies and Soothing Sounds

1. Press   to enter the main menu.
2. Press  or  to highlight  (**Lullaby**).
3. Press   to toggle between  (**Play**) and  (**Stop**).
4. To select a lullaby or soothing sound, press  or  to highlight  (**Lullabies**) or  (**Soothing Sound**), then press  .
5. For soothing sounds, press  or  to highlight a sound  **1**  **2**  **3**  **4**, then press  , or you can select a lullaby or play all five lullabies.
6. For playing lullabies, press  or  to highlight  **1**  **2**  **3**  **4**  **5**, or you can select  to play all lullabies repeatedly. Press   to confirm your selection.
7. You can also set the timer to stop playing the selected melodies or soothing sound. Press  or  to highlight  (**Timer**), and press  . Then, press  or  to highlight **60min** **45min** **30min** **15min** **OFF**, and press   to confirm your setting.

# Night Light





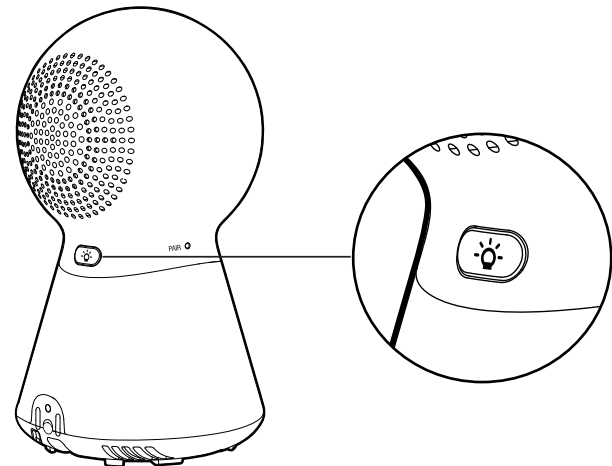

You can control the night light remotely on the parent unit or directly unit.

## On the Baby Unit



Press the **Night light on/off key**  located on the back of the baby unit to turn on/off the night light.



## On the Parent Unit

1. Press   to enter the main menu.
2. Press  or  to highlight  (**Night Light**) menu, then press   to enter.











### To turn on/off the night light:

- Press   to toggle between **ON** or **OFF**.





### To change the night light colour:

- Press  or  to scroll to  (**Night Light Colour**), press  . Then, press  or  to select one of the seven colours       , or you can select  to change to all seven colours in cycles. Press   to confirm your selection.

### To set the night light timer:

- Press  or  to scroll to  (**Timer**), press  . Then, press  or  to set timer **60min** **30min** **15min** to turn the night light off. Or select **OFF** to keep the night light on, and press   to confirm your setting.
- Set timer to  **AUTO** turn on the night light when baby unit detects sound. It will turn off after 15 minutes of no sound detection. You can set **VOX sensitivity level** to detect sounds that exceed certain levels. See **Sound sensitivity** and **Sound activation** section.

### To turn on/off the ambience light:

- Press  or  to scroll to , press  . Turn on/off the adaptive night light feature. When this feature is on, the baby unit detects the ambience light. If the room is bright, the night light adjusts itself to be brighter; if the room is dim, the night light adjusts itself to be less bright.

# Sound Sensitivity and Sound Activation

## Adjust sound detection sensitivity





You can turn on **Sound activation** and adjust the **VOX sensitivity** to detect sounds and turn on the parent unit while its screen is switched off or dimmed.

When the baby unit detects sounds that exceed certain levels, the parent unit screen will turn on and the baby unit starts transmitting the sounds to the parent unit, and you can see and hear your baby. If you have turned on the **Night light Auto-on** and the **Projection light Auto-on** feature, they will turn on automatically to sooth your baby.

If you turn off **Sound activation**, you will hear sounds from the baby unit all the time, even when the parent unit screen is switched off.

If you have turned on sound alert, the parent unit beeps when the baby unit detects sounds while in **Split** mode (\*For **BM4200N-2** only).

## Adjust sound detection sensitivity

VOX SENSITIVITY LEVEL	Level 5 (Highest)	Level 4 (High)	Level 3 (Medium)	Level 2 (Low)	Level 1 (Lowest)
					
DESCRIPTION	(Default setting) The parent unit screen and speaker turn on for very small sounds, including background noises from your baby's room.	The parent unit screen and speaker turn on for soft babbling and louder sounds from your baby. The parent unit remains quiet when your baby sleeps soundly.	The parent unit screen and speaker turns on for loud babbling and louder sounds from your baby. The parent unit remains quiet when your baby makes soft sounds.	The parent unit screen and speaker turn on for crying and louder sounds from your baby. The parent unit remains quiet when your baby makes soft sounds.	The parent unit screen and speaker turn on for loud crying or screeching sounds from your baby. The parent unit remains quiet when your baby makes soft sounds.



# Sound activated screen and audio

When **Sound activation** is on, the parent unit screen stays off to save power when the baby unit detects no sound.







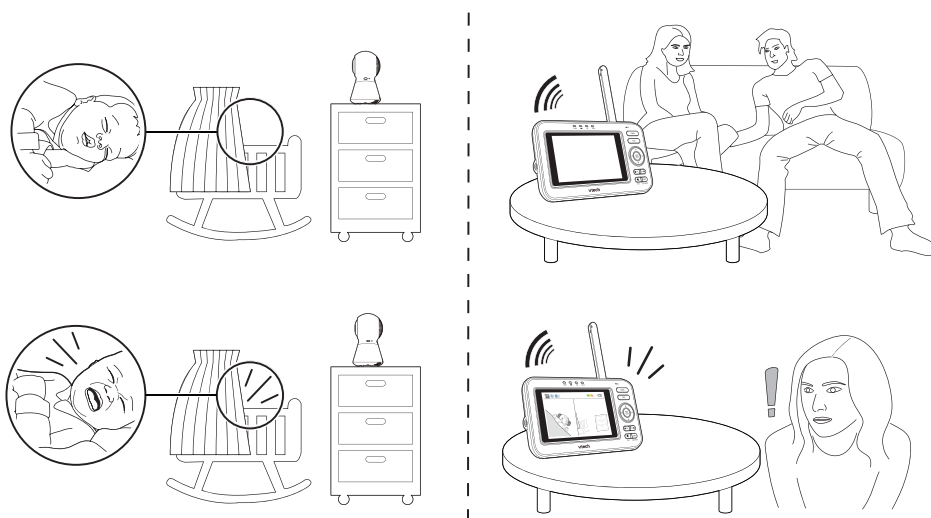







Once the baby unit detects sounds that are louder than the chosen sound sensitivity level, the parent unit screen and speaker turn on automatically. The parent unit will then turn off again after 50 seconds of no sound detection.

## Note:

- If you have muted the parent unit speaker, only the parent unit screen will turn on when a sound is detected.



## To turn on or off the sound activation feature:

1. Press   when the parent unit is idle.
2. Press  or  to highlight .
3. Press  or  to highlight  (**Sound Activation**), press  .
4. Press  or  to select **ON** or **OFF**, then press   to confirm.













# Temperature

## Temperature Alert

Your baby unit can help you keep track of your baby's room temperature in order to ensure that your baby stays in the comfort zone at all times.























With temperature sensor, the relevant data will be shown on the status bar when you powered on your units. If the detected temperature is out of the preset temperature range, the parent unit beeps.

### *Turn on/off the Temperature Alert*

1. Press  |  when the parent unit is idle.
2. Press  or  to go to  (Temperature).
3. Press  |  to select  (Temperature alert).
4. Press  or  to go to **ON** or **OFF**, then press  |  to turn on or off temperature alert.













## Set Temperature Range

You can set the desired room temperature alert range. The minimum temperature can be set between **50°F (10°C)** and **76°F (24°C)**. The maximum temperature can be set between **77°F (25°C)** and **102°F (39°C)**.

1. Press  |  when the parent unit is idle.
2. Press  or  to go to  (Temperature).
3. Press  or  to highlight   (**Minimum Temperature**), then press  | .
4. Press  or  to select the desired minimum temperature, and then press to  |  confirm.
5. Press  to go to   (**Maximum Temperature**).
6. Press  or  to select the desired maximum temperature, and then press  |  to confirm.

## Set Temperature Format

You can choose to display the temperature in Fahrenheit (°F) or Celsius (°C)

1. Press  |  when the parent unit is idle.
2. Press  or  to go to  (Temperature).
3. Press  or  to highlight **°F °C** (Temperature format), then press  | .
4. Press  or  to select the desired format, and then press  |  to confirm.















# Turn on/off Alert Tones

## Low Battery Alert Tone

You can set the parent unit to beep when the parent unit operates in low battery condition.

Switch it off if you do not wish to be disturbed when the parent unit's battery is running low.















### To turn on or off low battery alert:

1. Press   on the parent unit.
2. Press  or  to highlight  (**Alert settings**), then press  .
3. Press  or  to highlight  (**Low battery alert**), then press  .
4. Press   to toggle between **ON** and **OFF**.

## No Link Alert Tone

You can set the parent unit to beep when the link between the parent unit and the baby unit is lost. If you are using only one baby unit with a parent unit, but paired with two baby units, the No Link Alert Tone will activate until you have both paired baby units linked to the parent unit. To continue using one baby unit, switch off the No Link Alert Tone so you won't be disturbed.















### To turn on or off lost link alert:

1. Press   on the parent unit.
2. Press  or  to highlight  (**Alert settings**), then press  .
3. Press  or  to highlight  (**Lost link alert**), then press  .
4. Press   to toggle between **ON** and **OFF**.

## Confirmation Tone

When you turn on Confirmation Tone alert, the parent unit plays a confirmation tone whenever a setting is saved or item is selected.















### Turn on or off confirmation tone alert:

1. Press   on the parent unit.
2. Press  or  to highlight  (**Alert settings**), then press  .
3. Press  or  to highlight  (**Confirmation tone**), then press  .
4. Press   to toggle between **ON** and **OFF**.

















# Sound Detection in Split Mode Alert Tone

You can turn on sound alert, and set the parent unit to beep when the baby unit detects sounds while in Split mode (For BM4200N-2 only).

## Turn on or off sound alert:

1. Press   on the parent unit.
2. Press  or  to highlight  (**Alert settings**), then press  .
3. Press  or  to highlight  (**Sound detection alert on split screen**), then press  .
4. Press   to toggle between **ON** and **OFF**.

# Adjust Baby Unit Speaker Volume

1. Press   on the parent unit.
2. Press  or  to highlight  (**Baby Unit Settings**), then press  .
3. Press  or  to highlight  (**Baby Unit Speaker Volume**), then press  .
4. Press  to increase or press  to decrease the **Volume**, then press   to confirm your setting.

# Dim Mode

The parent unit display will dim to conserve energy after 10 minutes of inactivity, in which there is neither key pressed nor alert received from the baby unit.

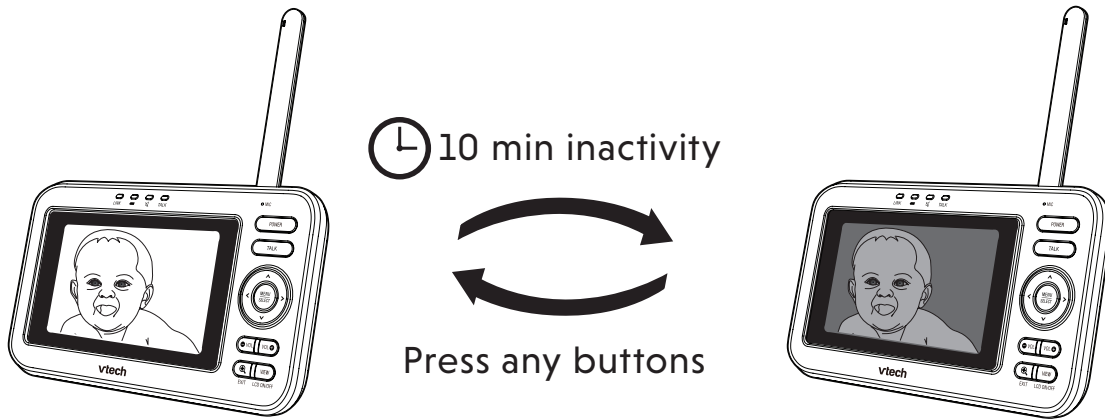

# Night Vision

The baby unit has infrared LEDs that allow you to see your baby clearly at night or in a dark room. When the baby unit being viewed detects low light levels, the infrared LEDs are switched on automatically. The images from the baby unit are in black and white, and 🌙 appears on the screen.





## Notes:

- It is normal if you see a short white glare on your parent unit screen as the baby unit is adapting to the dark environment.
- When the infrared LEDs are on, the images are in black and white. This is normal.

**Tip:** Depending on the surroundings and other interfering factors, like lightings, objects, colors and backgrounds, the video quality may vary. Adjust the baby unit's angle or place the baby unit at a higher level to prevent glare and blurry display.

# Monitoring Modes (BM4200N-2 only)

When more than one baby unit is paired to the parent unit, you can choose to view different baby units in three monitoring modes. Learn more about each below:



<b>Single Mode</b>		The screen displays images only from the selected baby unit in full screen.
<b>Split Mode</b>		The screen displays images from all paired baby units at the same time in split view.
<b>Patrol Mode</b>		The screen displays a single cam view that transitions to a different baby unit every 10 seconds.

## Status check - Two baby units

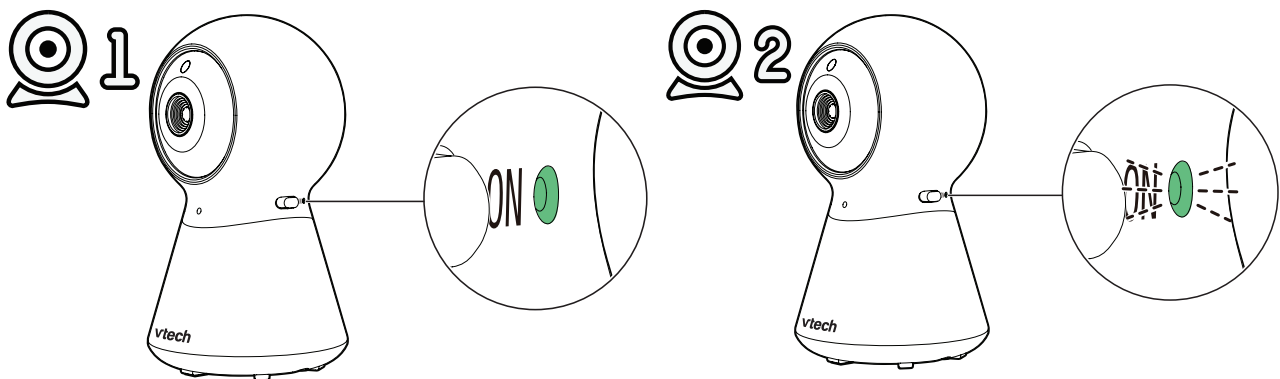
If you are viewing baby unit ①, the POWER LED light of baby unit ① turns on. As baby unit ② is not being viewed, its POWER LED light flashes.



### Notes:

- If you power on only one baby unit, you may see the parent unit displaying  and then , and the **LINK** LED light flashing.
- Press **VIEW** in **Single CAM** or **Patrol** mode to switch to the baby unit you have powered on.



## Change different views - Single CAM

In **Single CAM** or **Patrol** mode, press **VIEW** to switch between the image of baby units ① and ②.

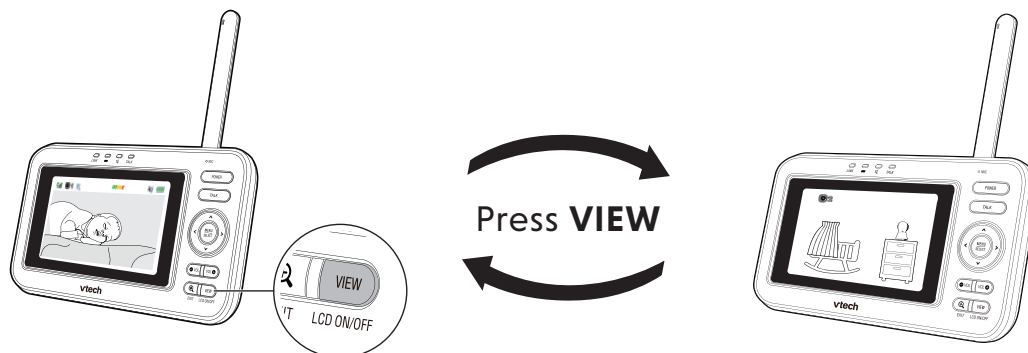

## Change different views - Patrol

Select **Patrol** as your monitoring mode to alternately view the image from baby units ① and ② every 10 seconds.

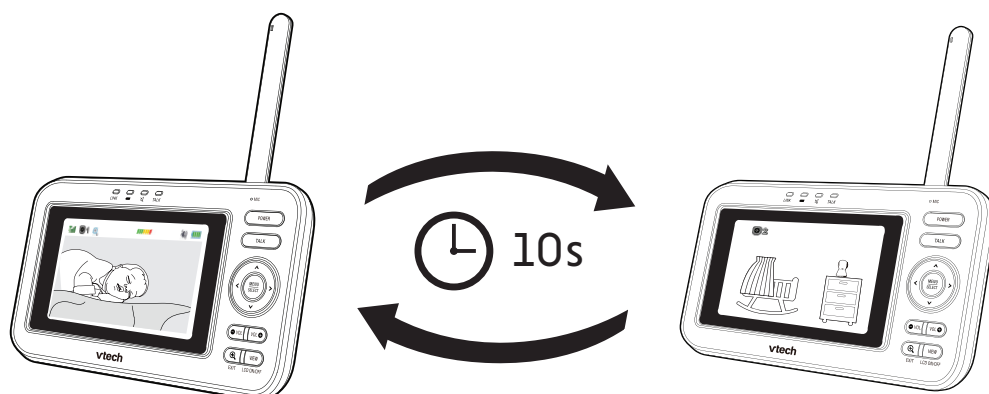

## Change different views - Split

Select **Split** as your monitoring mode to view the images from both baby units at once.

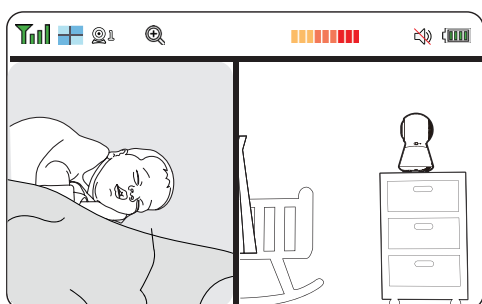

# Additional Information

## Wall Mount (Optional)

### Notes:

- Check for reception strength and camera angle before drilling the holes.
  - The types of screws and anchors you need depend on the composition of the wall. You may need to purchase the screws and anchors separately to mount your camera units.
1. Place the wall mount bracket on a wall and then use a pencil to mark two holes in parallel. Remove the wall mount bracket and drill two holes in the wall (7/32 inch drill bit).

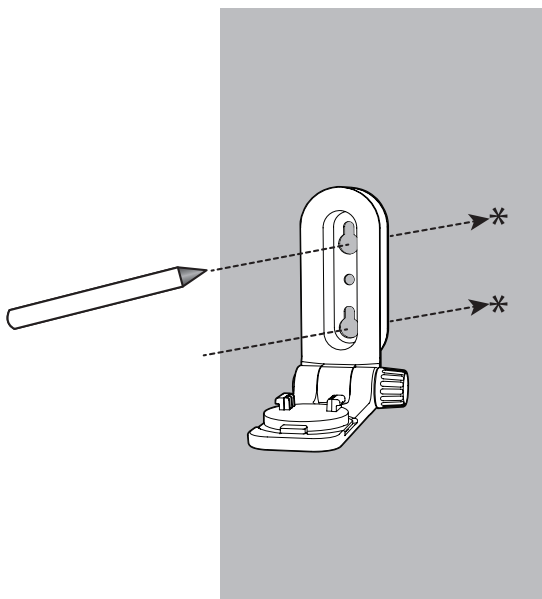

2. If you drill the holes into a stud, go to step 3.
- If you drill the holes into an object other than a stud, insert the wall anchors into the holes. Tap gently on the ends with a hammer until the wall anchors are flush with the wall.

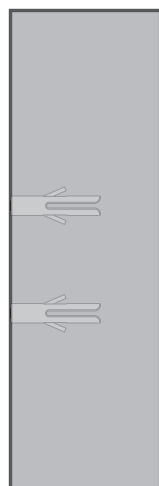

3. Align the wall mount bracket and screws with the holes in the wall as shown. Tighten the screw in the middle hole first, so that the wall mount bracket position is fixed. You can tighten the other screw in the top hole.

**OR**

Insert the screws into the holes and tighten the screws until only 1/4 inch of the screws are exposed.

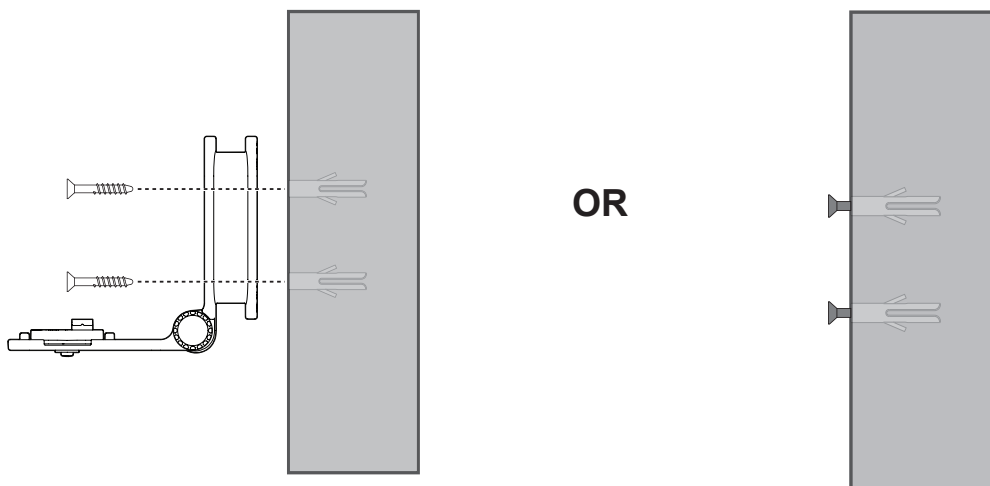

4. Place the camera unit on the wall mount bracket, and then slide it forward until it locks into place. Connect the power adapter to the camera unit and a power supply not controlled by a wall switch.

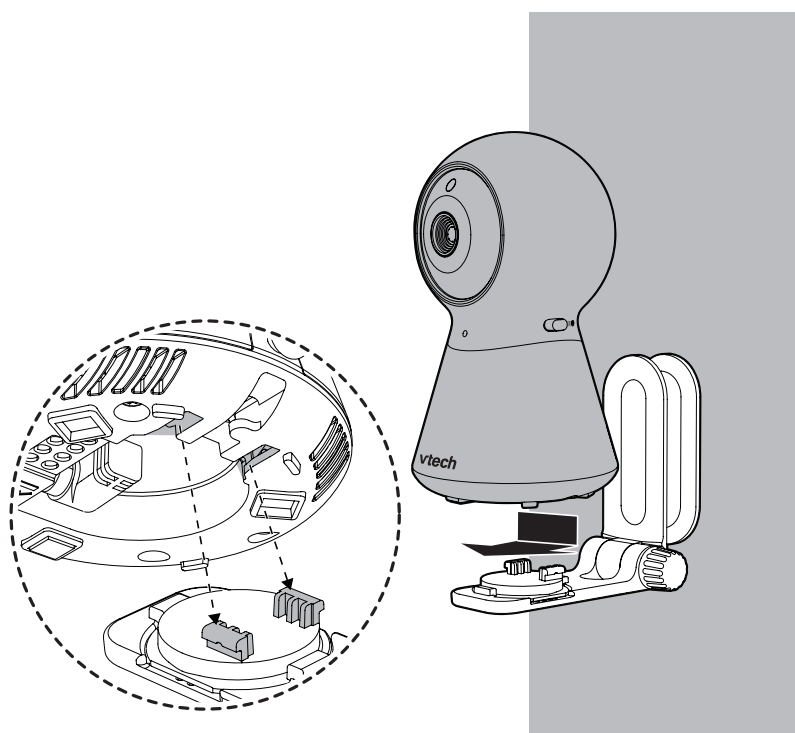

**OR**

Place the camera unit on the wall mount bracket, and then slide it forward until it locks into place. Align the holes on the wall mount bracket with the screws on the wall, and slide the wall mount bracket down until it locks into place.

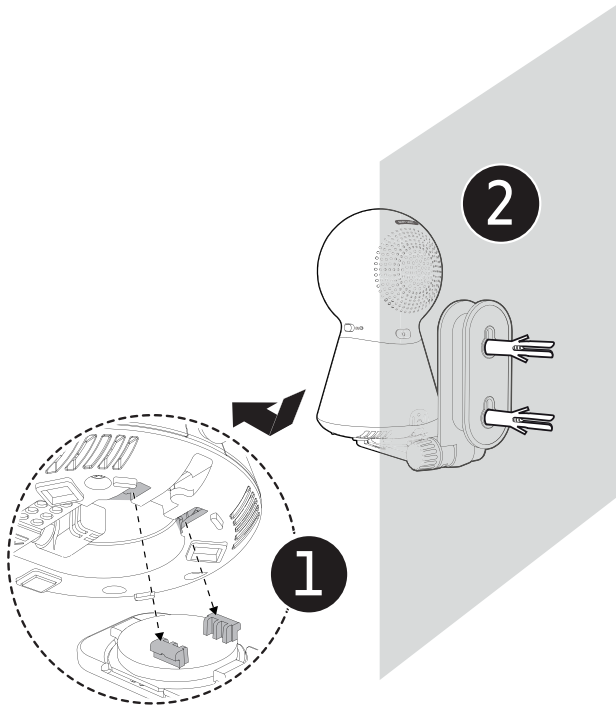

5. You can maximize your camera unit's viewing angles by tilting the wall mount bracket.

Hold the camera unit, and then rotate the knob in anticlockwise direction. This will loosen the joint of the wall mount bracket.

Tilt your camera unit up or down to adjust to your preferred angle. Then, rotate the knob in clockwise direction to tighten the joint and secure the angle.

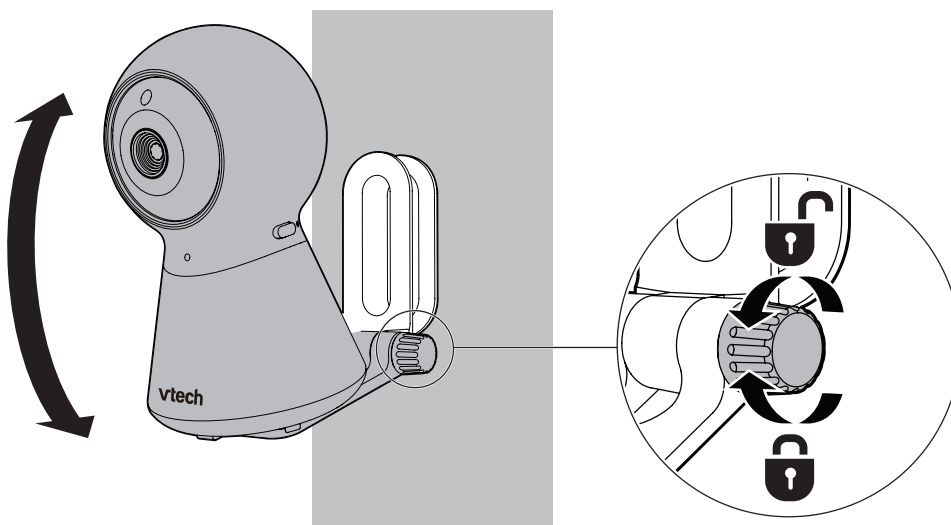

# General Product Care

To keep this product working well and looking good, follow these guidelines:

- Avoid putting it near heating appliances and devices that generate electrical noise (for example, motors or fluorescent lamps).
- DO NOT expose it to direct sunlight or moisture.
- Avoid dropping the product or treating it roughly.
- Clean with a soft cloth.
- DO NOT immerse the parent unit and the baby unit in water and do not clean them under the tap.
- DO NOT use cleaning spray or liquid cleaners.
- Make sure the parent unit and the baby unit are dry before you connect them to the mains again.

## Storage

When you are not going to use the HD video monitor for some time, store the parent unit, the baby unit and the adapters in a cool and dry place.

## Technical Specifications

Frequency control	Crystal controlled PLL synthesizer
Transmit frequency	Baby unit: 2405 - 2475 MHz Parent unit: 2405 - 2475 MHz
Channels	32
LCD	4.3" Color LCD (WQVGA 480x272 pixel)
Nominal effective range	Actual operating range may vary according to environmental conditions at the time of use.
Power requirements	Parent unit: 3.8V 2100mAh, Li-ion battery Baby unit power adapter: Output: 5V DC @ 600mA Parent unit power adapter: Output: 5V DC @ 1A

### Credits:

The Background Noise sound file was created by Caroline Ford, and is used under the Creative Commons license.

The Stream Noise sound file was created by Caroline Ford, and is used under the Creative Commons license.

The Crickets At Night sound file was created by Mike Koenig, and is used under the Creative Commons license.

The Heart Beat sound file was created by Zarabadeu, and is used under the Creative Commons license.

# Customer service and product warranty

## IMPORTANT

Please retain this booklet with your sales receipt as proof of the date of purchase.

### Customer Service

If you require assistance in operating this product, please call the TechHelp Information Line on 1300 369 193 or contact VTech by e-mail at: [tcpsupport\\_au@vtech.com](mailto:tcpsupport_au@vtech.com).

### Voluntary Product Enquiry

In addition to your Statutory Rights and subject to the conditions below, VTech warrants that this product will be free from any defect in materials or workmanship under conditions of normal use for a period of 24 months from date of purchase.

VTech does not warrant that the product will be free from defects if defects are caused by an accident, misuse, abuse, improper installation or operation, vermin infestations, lack of reasonable care, unauthorised modification, loss of parts, tampering or attempted repair by a person not authorised by VTech; or where the product has been damaged by lightning or a mains power surge. To make a claim under this Voluntary Product Warranty you must call the TechHelp Information Line on 1300 369 193 or contact VTech by e-mail at: [tcpsupport\\_au@vtech.com](mailto:tcpsupport_au@vtech.com) where a Customer Service Representative will inform you of the product return process. You will need to ensure that:

- You provide proof of purchase;
- Your product is suitably packaged (original packaging is not required); and
- You have included all components from the original purchase.

### For your records

Date of purchase:

---

Place of purchase:

---

Serial number:

---

For Voluntary Product Warranty purposes, proof of purchase is required so please keep your receipt.

The benefits conferred by this Voluntary Product Warranty are in addition to other rights and remedies that are available to you under law, which cannot be excluded. The processes for this Voluntary Product Warranty in no way limit your rights which arise as a result of your Statutory Rights.

This Voluntary Product Warranty is given by:

VTech Telecommunications (Australia) Pty Ltd ABN 70 136 672 627

Address: 24 Gilby Road, Mount Waverley 3149

**IMPORTANT NOTE: THIS IS NOT A PRODUCT RETURN OR SERVICE ADDRESS – PLEASE CONTACT TECHHELP BY PHONE OR EMAIL FOR PRODUCT AND WARRANTY SUPPORT. NO LIABILITY WILL BE ACCEPTED BY VTECH FOR PRODUCTS RETURNED TO THIS ADDRESS UNDER THIS VOLUNTARY PRODUCT WARRANTY.**

Phone number: 1300 369 193

Email address: [tcpsupport\\_au@vtech.com](mailto:tcpsupport_au@vtech.com)

### Statutory Rights

Our goods come with guarantees that cannot be excluded under the Australian Consumer Law. You are entitled to a replacement or refund for a major failure and compensation for any other reasonably foreseeable loss or damage. You are also entitled to have the goods repaired or replaced if the goods fail to be of acceptable quality and the failure does not amount to a major failure.

# Disposal of Batteries and Product



The crossed-out wheelee bin symbols on products and batteries, or on their respective packaging, indicates they must not be disposed of in domestic waste as they contain substances that can be damaging to the environment and human health.



The chemical symbols Hg, Cd or Pb, where marked, indicate that the battery contains more than the specified value of mercury (Hg), cadmium (Cd) or lead (Pb) set out in Battery Directive (2006/66/EC).

The solid bar indicates that the product was placed on the market after 13th August, 2005.



Help protect the environment by disposing of your product or batteries responsibly.