

4358-7119  
9.2.16

**Safety** <sup>1st</sup>  
**onBoard™ 35**

**Infant Car Seat**

4-35 lb (1.8-15.9 kg) and 32 in. (81.3 cm) or less

KEEP INSTRUCTIONS  
FOR FUTURE USE.

Read all instructions  
before using this  
child restraint.



**Safety** <sup>1st</sup>

[www.safety1st.com](http://www.safety1st.com)

©2016 Dorel Juvenile.

**⚠ WARNING:**

Failure to follow the warnings on the labels and in the instruction manual can result in serious injury or death to your child.

**A. Before You Begin**.....Pages 3-8

- A-1 Dorel Juvenile Group Information
- A-2 Registration and Safety Notices
- A-3 Understanding Your Child Restraint

**B. Safety Information**.....Pages 9-10

- B-1 Vehicle Seating Position
- B-2 Installation in Vehicle
- B-3 Child Restraint Use

**C. Basic Use**.....Pages 11-31

- C-1 Remove and Install the Carrier to Base
- C-2 Canopy Use and Installation
- C-3 Carrier Use
- C-4 Child Restraint Use
- C-5 Preparing Child Restraint to Fit Your Child
- C-6 Securing Child in Child Restraint
- C-7 Removing Child from Child Restraint
- C-8 Reclining the Base
- C-9 Removing Harness System
- C-10 Removing Pad for Cleaning
- C-11 Installing Harness System
- C-12 Accessories on Select Models

**D. General Vehicle Information**.....Pages 32-39

- D-1 Vehicle Seating Position
- D-2 Choosing Lower Anchor or Vehicle Belts
- D-3 Knowing Your Vehicle Belts
- D-4 Aircraft Information
- D-5 Storing Lower Anchor Belt

**E. Installing Rear Facing**.....Pages 40-51

E-1 Rear Facing Installation with Base

E-2 Installing Base with Lower Anchor Belt



E-3 Installing Base with Vehicle Belts



E-4 Rear Facing Installation without Base

E-5 Installing Child Restraint with Vehicle Belts



**General Information**..... Pages 52-58

- Using a Locking Clip
- Troubleshooting
- Replacement Parts Order Form
- Warranty

## A-1 Dorel Juvenile Group Information

Thank you for choosing this child restraint. The DJG family is committed to creating child restraints with the most comfort and convenience available today.

Remember, parents are a child's first teachers and examples. If you always buckle your seat belt, your child will think it is the natural thing to do. Make it a firm rule that the vehicle does not go until everyone is buckled up. Make no exceptions.

No one can predict if use of a child restraint will prevent injury or death in a particular crash. However, when combined with careful driving, proper use of a child restraint can lower a child's risk of injury or death in most crashes.

Your child's safety is worth the time it will take to read and follow these instructions. After reading, if you still have questions or have any concerns with this child restraint, please contact our Consumer Care Department at:

### Dorel Juvenile Group, Inc.

**Website:** [www.safety1st.com](http://www.safety1st.com)

**Mailing Address:** Dorel Juvenile Group, Inc.  
Consumer Care Department  
P.O. Box 2609  
Columbus, IN 47202-2609

**Telephone:** 1-800-544-1108  
8 A.M. to 6 P.M. EST M-TH  
8 A.M. to 4:30 P.M. EST FRI

## A-2 Registration and Safety Notices

Please complete the postage-paid registration card that came with your child restraint, and send it to us. Child restraints could be recalled for safety reasons. You must register this restraint to be reached in a recall. Send your name, address, email address if available, the restraint's model number, and manufacturing date to:

**Dorel Juvenile Group, Inc.**  
**Consumer Care Department**  
PO Box 2609  
Columbus, IN 47202-2609

or call 1-800-544-1108 or register online at [www.djgusa.com/registration/carseat/us](http://www.djgusa.com/registration/carseat/us).

For recall information, call the U.S. Government's Vehicle Safety Hotline at 1-888-327-4236 (TTY: 1-800-424-9153), or go to <http://www.NHTSA.gov>.

A. Before You Begin

**Consumer:** Just fill in your name, address and email. Please print (use dark ink).

Your Name \_\_\_\_\_  
Your Street Address \_\_\_\_\_  
City \_\_\_\_\_ State \_\_\_\_\_ Zip Code \_\_\_\_\_

Model Number	Line Code	Manufacture Date
AB123CDE	S1 CARSEAT	01/22/2015

Model Name: S1 CARSEAT  
L#11 B265035



Example of model number, manufacture date, and line code.

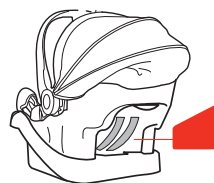

If you don't have the card or if your address changes, you will find the model number, manufacture date, and line code on the label located on side of shell.

## A-3 Understanding Your Child Restraint

Front View

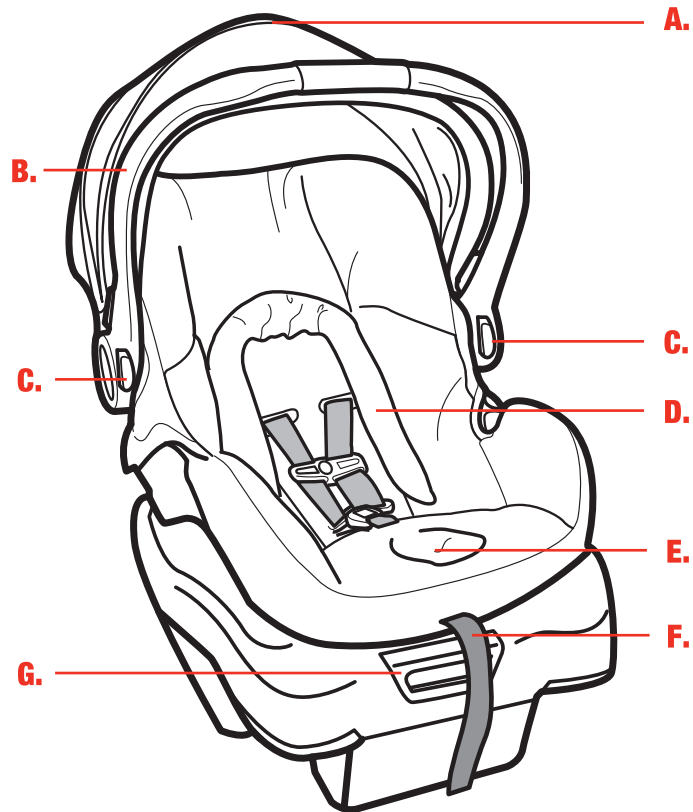

- A.** Canopy
- B.** Carry Handle
- C.** Handle Adjustment Button
- D.** Infant Insert (on select models)
- E.** Harness Release Lever (under flap)
- F.** Harness Adjustment Strap
- G.** Base Adjustment Button

Back View

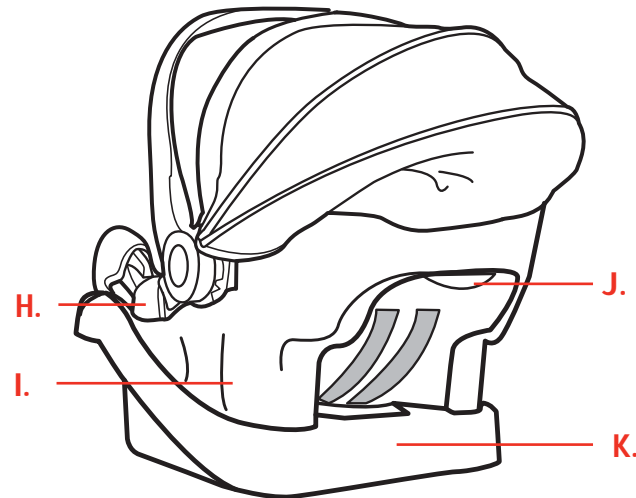

- H.** Angle Indicator
- I.** Carrier (shell)
- J.** Base Release Handle
- K.** Removable Base

A. Before You Begin

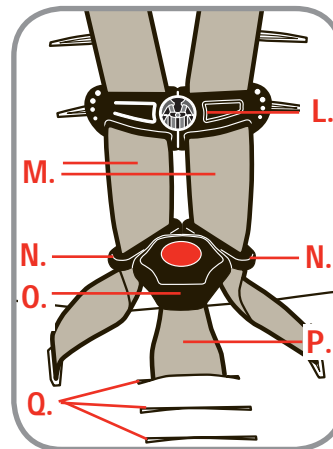

Harness System Detail

- L.** Chest Clip
- M.** Harness Straps
- N.** Buckle Tongue
- O.** Buckle
- P.** Buckle Strap
- Q.** Buckle Strap Slots

Bottom of Carrier

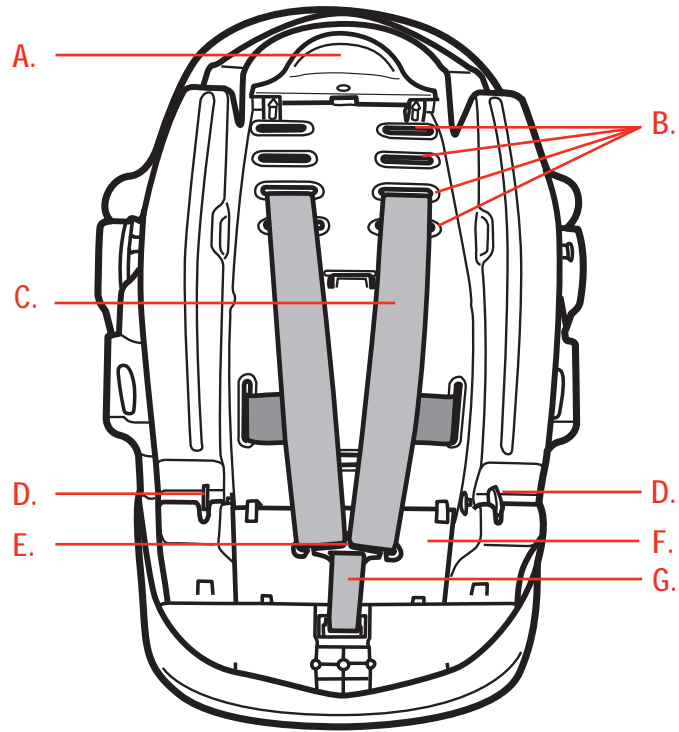

- A.** Base Release Lever
- B.** Harness Slots
- C.** Harness Straps
- D.** Base Attachment Hooks
- E.** Splitter Plate
- F.** Instruction Manual Storage
- G.** Harness Adjustment Strap

Top of Base

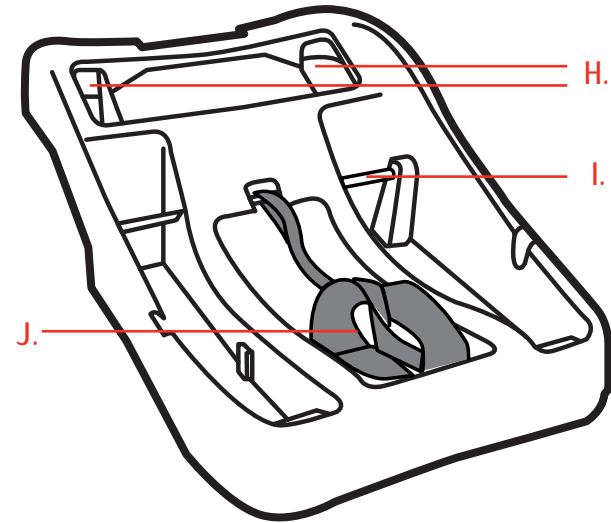

- H.** Base Belt Path Openings
- I.** Base/Carrier Lock Bar
- J.** Lower Anchor Belt

A. Before You Begin

### B-1 Vehicle Seating Position



⚠ Never place a child rear facing in a seating position with an active frontal airbag.

⚠ Check the vehicle owner's manual for more information about airbag/child restraint use.

⚠ For vehicles without a back seat, refer to your vehicle owner's manual.

### B-2 Installation in Vehicle

⚠ Check the vehicle belt or lower anchor belt before each use. Use only if the belt is tightened properly and securely.

⚠ This child restraint should be securely belted in the vehicle even when not in use. In a crash or sudden stop, an unsecured child restraint could injure occupants.

⚠ Do not use a child restraint that has been in a crash. You must get a new child restraint.

### B-3 Child Restraint Use

⚠ Never take your child out of the child restraint while the vehicle is moving.

⚠ Never leave child unattended.

⚠ Placing your child in a hot child restraint may result in burns.

⚠ Do not use a child restraint with damaged or missing parts.

⚠ Do not use cut, frayed or damaged harnesses.

⚠ Do not lubricate buckles and fasteners.

⚠ Do not substitute parts or try to modify the child restraint in any way.

⚠ Do not use any child restraint accessory except those approved by Dorel Juvenile Group.

⚠ Never allow any child to play with this child restraint; it is not a toy.

⚠ Do not remove or cover up any of the warning labels or other labels on the child restraint.

⚠ Read all instructions for additional warnings.

⚠ On the back of the child restraint there is a date of manufacture label. Do not use this child restraint more than 8 years after the date of manufacture.

## C-1 Remove and Install the Carrier to Base

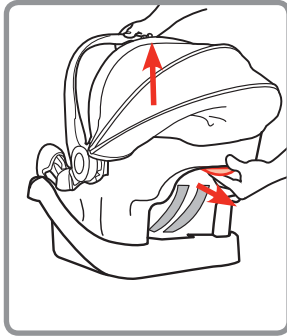

### To Remove Carrier from Base

From the back of the carrier, pull the base release handle out and lift the carrier out of the base.

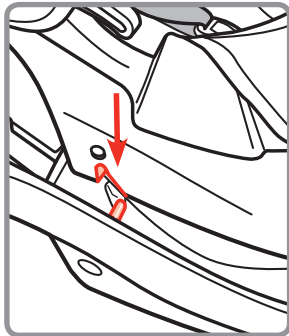

### To Attach Carrier to Base

Align the notches in the front of carrier with the base lock bar.

Push down firmly to lock. You will hear a "click" when it is locked.

Pull up on carrier to make sure it is locked.

### **⚠ WARNING:**

Failure to securely attach carrier to base can result in serious injury or death.

## C-2 Canopy Use and Installation

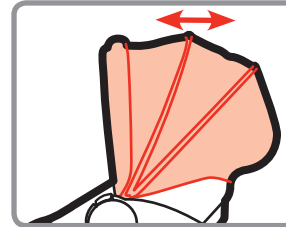

### To Adjust Canopy

Grasp the front of the canopy and move it forwards or backwards to desired location.

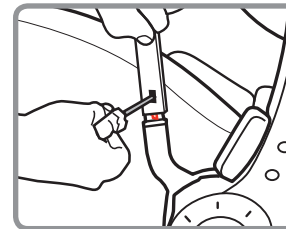

### Remove Canopy

Press on canopy tab locks on canopy posts as shown. Pull canopy hoop off posts. Remove plastic strip from canopy.

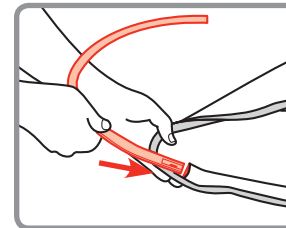

### 1. To Install Canopy

Completely thread the plastic strip through the tunnel in front edge of the canopy.

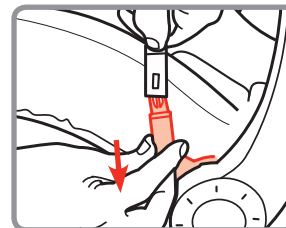

### 2. Attach Canopy to Carrier

Fit back of canopy over back of carrier.

Snap each plastic strip end to each canopy post.

### C-3 Carrier Use

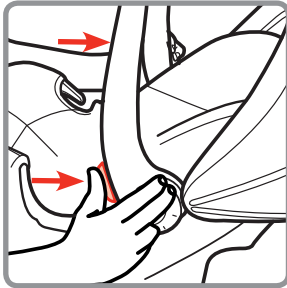

#### To Adjust Carrying Handle

Squeeze both adjustment buttons on each side of handle.

Rotate up or down to desired location.

Release buttons.

Make sure both handle adjuster buttons are locked.

Carry handle **MUST** be upright AND locked when carrying and when installed in the vehicle.

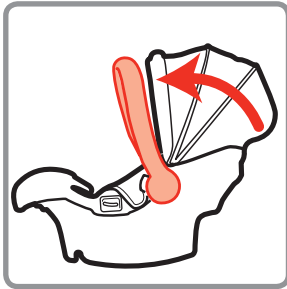

#### **WARNING:**



**DO NOT** use in the seating area or across the top of shopping carts.

#### **WARNING:**

Read ALL instructions before using child restraint as a carrier.

**NEVER** use carrier unless child is properly secured.

Use only as a carrier by children weighing 4-35 pounds (1.8-15.9 kg) and 32 inches (81.3 cm) or less.

**NEVER** leave child unattended. Always keep child within arm's reach.

**Suffocation Hazard:** Infant carrier can roll over on soft surfaces and suffocate child.

**NEVER** place carrier on beds, sofas or other soft surfaces.

**Strangulation Hazard:** Children have **STRANGL**ED in loose or partially buckled harness straps. Fully restrain the child even when carrier is used outside the vehicle.

**Fall Hazard:** Child's movement can slide carrier. **NEVER** place carrier near edges of counter tops, tables or other elevated surfaces.

Do not use the carrier if it is damaged or broken, or if any parts are missing.



## C-4 Child Restraint Use

Your child's height, weight, and age determine how your child restraint should be placed in the vehicle.

Children up to 1 year of age must ride rear facing.

The American Academy of Pediatrics recommends that children should remain rear facing until they are at least 2 years old.

Please talk to your doctor about the best option for your child.

**This child restraint must always be used rear facing.**

**⚠ WARNING:** Verify your child's weight and height (do not guess) before using the child restraint.

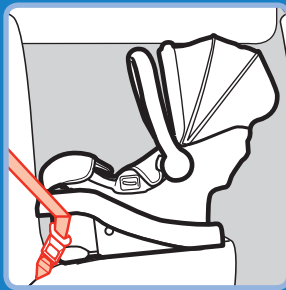

**4-35 lb (1.8-15.9 kg) and 32 in. (81.3 cm) or less**

### Rear Facing with base:

Child and child restraint with base face the back of the vehicle and are placed in the back seat.

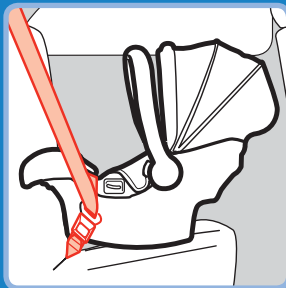

**4-35 lb (1.8-15.9 kg) and 32 in. (81.3 cm) or less**

### Rear Facing without base:

Child and child restraint without base face the back of the vehicle and are placed in the back seat.

## C-5 Preparing Child Restraint to Fit Your Child

**You MUST make these adjustments with your child before you install the child restraint in the vehicle.**

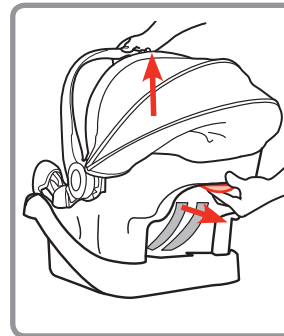

### 1. To Remove Carrier from Base

From the back of the carrier, pull the base release handle out and lift the carrier out of the base.

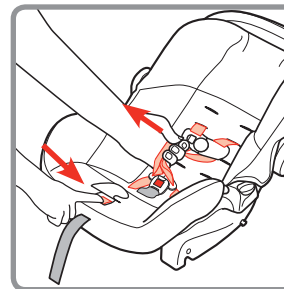

### 2. Loosen Harness

Push down on the harness release lever (under flap on the front of restraint) while pulling out on the harness as shown.

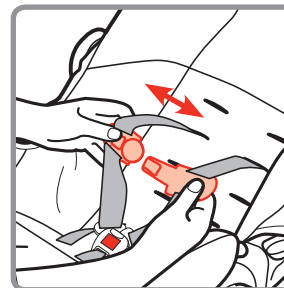

### 3. Release Chest Clip

Press on chest clip release button and pull apart.

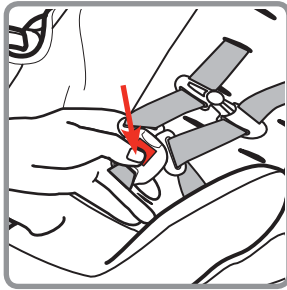

- 4. Unbuckle Harness**  
 Press red button.  
 Pull buckle tongues out.  
 Place harness straps out of the way.



- 5. Place Child in Child Restraint**  
 Place the child's bottom and back flat against the restraint.  
 This will allow the harness straps to be properly tightened.

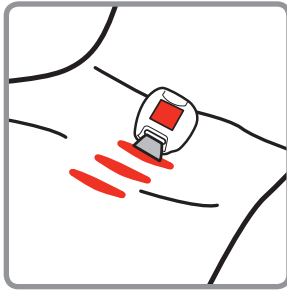

- 6. Check Buckle Position**  
 Determine which of the available buckle positions will provide a snug fit for your child.

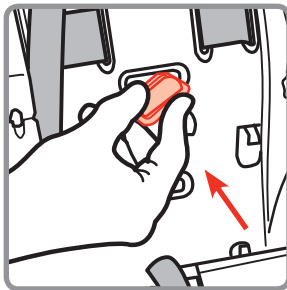

- 7. To Change Buckle Position**  
 Remove child.  
 From under the seat, rotate the metal retainer then insert retainer up through the carrier and pad.

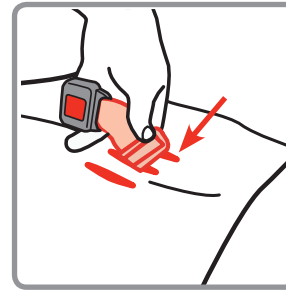

- a. For small infants, skip to step c.  
 Insert the buckle's metal retainer through the desired slot.  
 Make sure that the buckle is **facing out**.

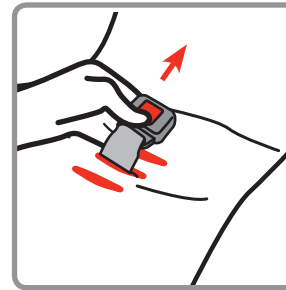

- b. Pull up on buckle strap to make sure it is secured.  
**The buckle must not pull out.**

**⚠ WARNING:**  
 Failure to reinstall the harness system correctly can result in serious injury or death.



- c. **Buckle Placement for Small Infants**  
 Choose the slot closest to the back of the restraint.  
 Push metal retainer through the pad and carrier.  
 Make sure that the buckle is **facing out**.

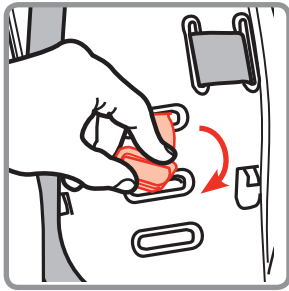

d. From the bottom, pull the metal retainer through the carrier and insert it into the middle slot.

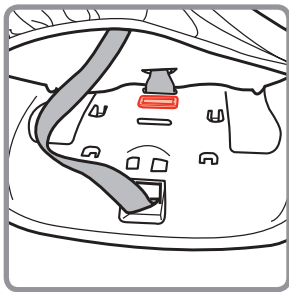

e. From the front, lift pad up and place the buckle's metal retainer flush on bottom of the carrier.  
Replace the pad.

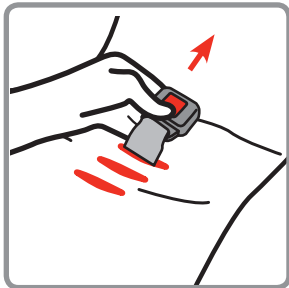

f. Pull up on buckle strap to make sure it is secured.  
**The buckle must not pull out.**

**⚠ WARNING:**  
Failure to reinstall the harness system correctly can result in serious injury or death.

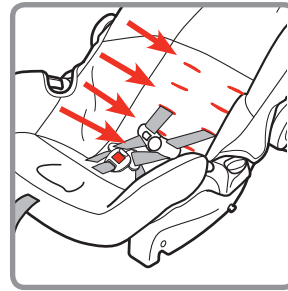

### 8. Check Harness Height

With child in the child restraint, check the location of the harness slot.

Follow the guidelines below to determine the correct harness height.



**Rear-Facing Position**  
Harness straps **MUST** be at or slightly below the shoulders.  
If the lowest shoulder harness slots are above the child's shoulders, **do not** use this child restraint.

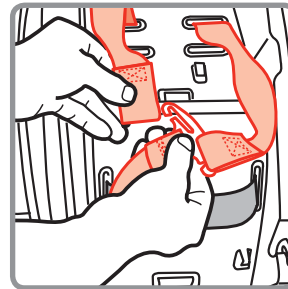

### 9. To Change Harness Location

With harness system loose, from the back, remove harness from the splitter plate.

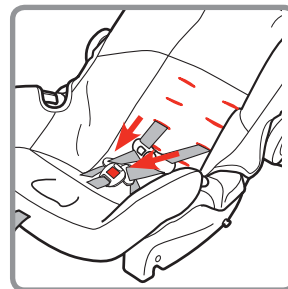

10. From the front of child restraint, pull harness straps out.

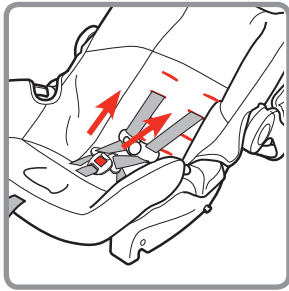

11. Rethread harness into new harness slot location.

Make sure harness straps do not twist.

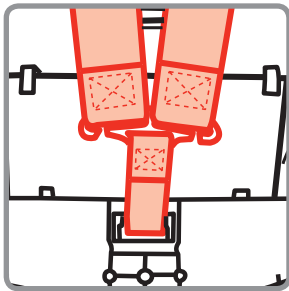

12. Attach Harness Straps to Splitter Plate

From the back of the child restraint, fit the harness strap loops onto the splitter plate.

The sewn end of the harness strap loops **MUST** face towards you.

**DO NOT** twist harness straps or harness adjustment strap and make sure the harness straps are **COMPLETELY ON** the splitter plate.

**⚠ WARNING:**



Do not use this child restraint if the top of your child's head is within 1 in. (2.5 cm) from the top of the child restraint.

Make sure the harness height is correct for your child's size.

Make sure you have reinstalled the harness system correctly.

Failure to follow these steps can result in serious injury or death.

### C-6 Securing Child in Child Restraint

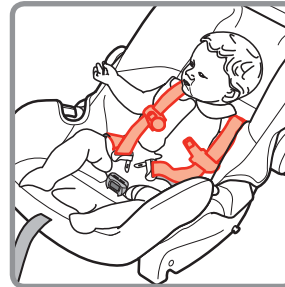

1. Position Harness Straps Over the Child's Shoulders

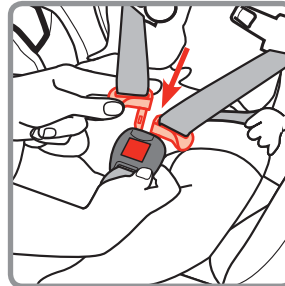

2. Buckle Harness

Push each buckle tongue into buckle until you hear a "click."

Pull up on harness straps to make sure buckle is locked.

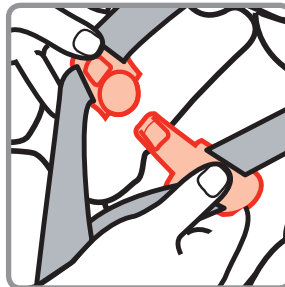

3. Close Chest Clip

Insert right half of chest clip into left half and snap together.

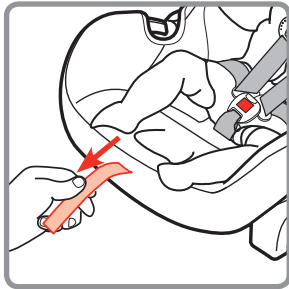

#### 4. Tighten Harness

Pull on harness adjustment strap to tighten harness snugly.

**NOTE:** A snug strap should not allow any slack. It lies in a relatively straight line without sagging. It does not press on the child's flesh or push the child's body into an unnatural position.



#### 5. Check Harness Tightness

Try to pinch the harness at the shoulders vertically between index finger and thumb.

If you can pinch the harness strap, tighten more.

If your fingers slip off, the harness is tight enough.

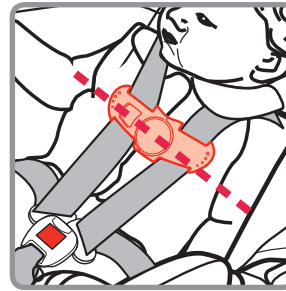

#### 6. Position Chest Clip

The chest clip must be placed at mid-chest (even with armpits) and away from the child's neck.

### **⚠ WARNING:**

Failure to fasten and tighten the harness system correctly may allow the child to be ejected from the child restraint in a crash or sudden stop causing serious injury or death.

Do not mistake comfort for safety. Harness system must be snugly adjusted.



**DO NOT** put snowsuits or bulky garments on your child when placing them in the child restraint.

Bulky clothing can prevent the harness straps from being tightened properly.

## C-7 Removing Child From Child Restraint

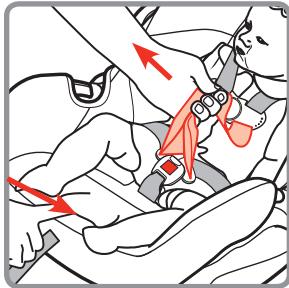

### 1. Loosen Harness

Push down on the harness release lever (under flap on the front of restraint) while pulling out on the harness as shown.

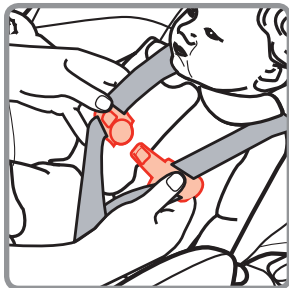

### 2. Release Chest Clip

Press on chest clip release button and pull apart.

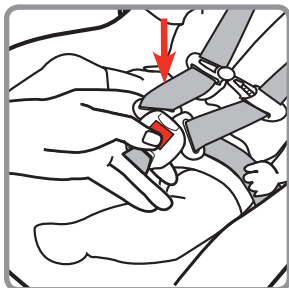

### 3. Unbuckle Harness

Press red button.  
Pull buckle tongues out.  
Place harness straps out of the way.  
Remove child.

## C-8 Reclining the Base

The base has multiple recline positions. Use any of these to help you achieve the recline angle needed for the weight of your child.

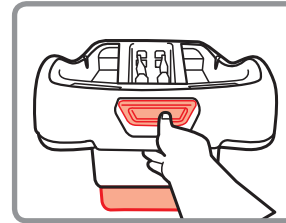

Push in on the base adjustment button and either lift or lower front of base.

## C-9 Removing Harness System

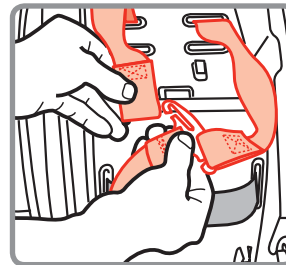

### 1. Remove Harness Straps from Splitter Plate

Fully loosen harness straps. Locate splitter plate on the back of the child restraint and unfasten the harness straps.

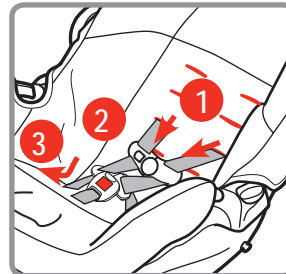

### 2. Remove Harness Straps

(1) Pull harness through the upper harness slots from the front.  
(2) Unthread harness from the chest clip.  
(3) **Do not unbuckle the buckle.** Unthread

harness from the buckle tongues.

You do not need to fully remove the harness strap from the shell.

## C-10 Removing Pad for Cleaning

You must remove the harness system to remove the pad from the shell. See section C-9.

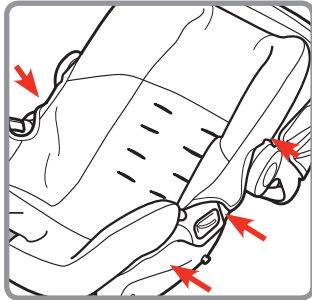

### 1. Release the Pad Tabs

To release the tab, pull down on the pad and pull the tab out of the carrier.

Depending on your model, unhook pad from the tabs at the top of the carrier (A).

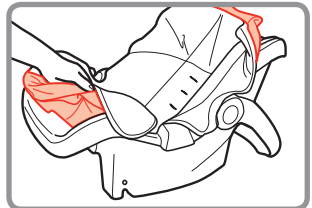
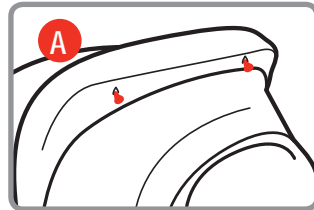
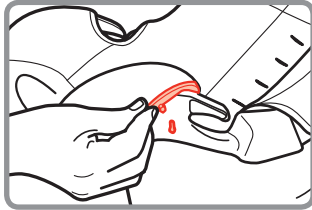

### 2. Remove Pad from Top and Bottom

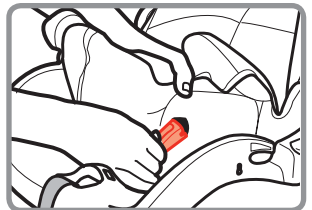

### 3. Pull Buckle Through Pad

Remove pad.

## Cleaning Pad

Machine wash separately with cold water on a gentle cycle. Do not use bleach. Tumble dry separately for 10-12 minutes on low heat. Remove immediately.

Spot clean the harness straps.

**⚠ WARNING:**

**Do not use child restraint without the pad.**

Replace child restraint pad by reversing order:

Starting from top of the child restraint, slip pad on shell.

Pull buckle and harness adjustment strap through pad.

Slip pad over front of shell.

Attach all of the tabs on the sides of shell.

Rethread harness (see section C-11).

## C-11 Installing Harness System

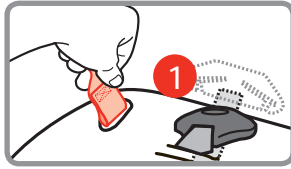

### 1. Thread Harness Strap

If you have fully removed the harness strap from the child restraint, (1) **with sewn end of the harness strap loop facing the buckle**, thread the harness strap down through lower harness slot on left side of shell.

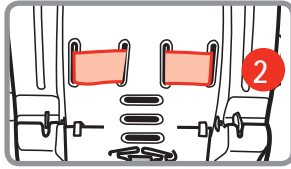

(2) Weave the harness in and out of the shell, between shell and pad, as shown.

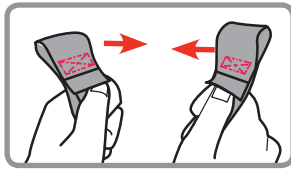

### 2. Take both ends of the harness strap and make them even in length.

The sewn ends of the harness strap loops **MUST** face each other as shown.

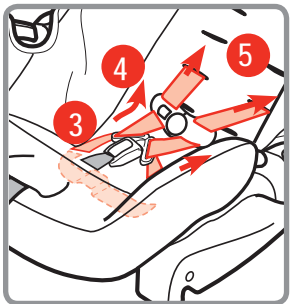

(3) Thread left harness strap through the **back** of the left buckle tongue. Repeat for right harness strap.

(4) Thread the chest clip from front to back as shown.

(5) Push harness ends through upper harness slots at same height.

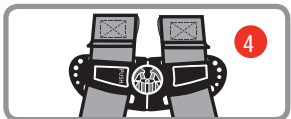

**DO NOT twist harness straps.**

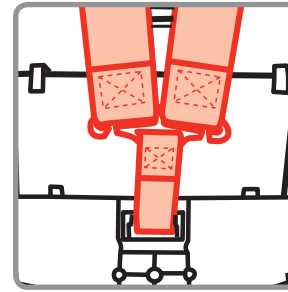

### 3. Attach Harness Straps to Splitter Plate

From the back of the child restraint, fit the harness strap loops onto the splitter plate.

The sewn end of the harness strap loops **MUST** face towards you.

**DO NOT twist harness straps or harness adjustment strap and make sure the harness straps are COMPLETELY ON the splitter plate.**

### **⚠ WARNING:**

**Failure to reinstall the harness system can result in serious injury or death.**



## C-12 Accessories on Select Models

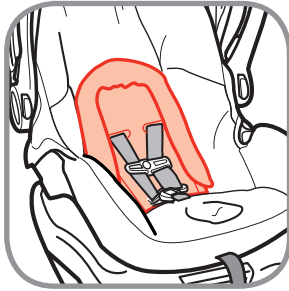

### Infant Insert

Infant insert **MUST NOT** cover the infant's face in any way.

Remove the insert when the infant's head has reached the top, inside part of the insert.

To remove this insert, undo the fastening strips and slide the insert out.

Reverse steps to replace support.

## D-1 Vehicle Seating Position



Never place a child rear facing in a seating position with an active frontal air bag.

Check the vehicle owner's manual for more information about air bag/child restraint use.



Use the child restraint only on vehicle seats that face forward.

Do not use on seats that face the sides or rear of the vehicle.



Use the center seating position if possible.

For vehicles without a back seat, refer to your vehicle owner's manual.

If you are not sure where to place the child restraint in your vehicle, consult your vehicle owner's manual, contact Dorel Juvenile Group Consumer Care Department or visit your local Child Passenger Inspection Station. Go to <http://www.safercar.gov/cpsApp/cps/index.htm> to find your closest station.



Children are safer when properly restrained in rear seating positions than in the front seating positions.

According to National Highway Traffic Safety Administration information, children in rear seating positions are statistically safer, whether you have air bags, advanced air bags, or no air bags at all.

**To avoid your child being seriously burned, take the following precautions:**

1. Park in the shade or where sun does not directly hit the child restraint.
2. Cover the child restraint with a sheet or blanket when not in use.
3. Check for hot seat and buckles before placing child in child restraint.

To help protect your vehicle seat's upholstery from damage, use a single layer towel underneath and behind child restraint.

## D-2 Choosing Lower Anchor or Vehicle Belts

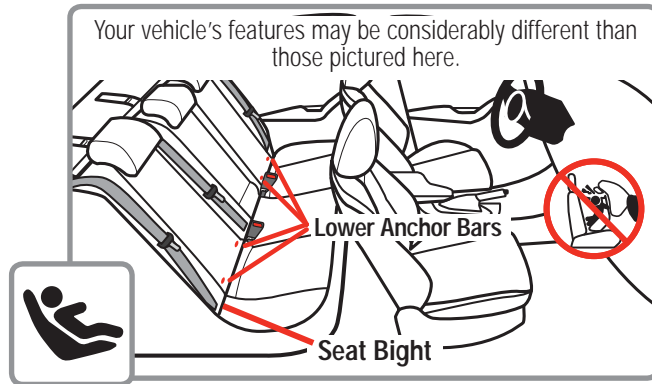

### The LATCH System

The lower anchors of LATCH (Lower Anchors and Tethers for CHildren) is a universal system for installing child restraints without using vehicle seat belts.

The lower anchor system can **ONLY** be used in vehicles that have the lower anchor bars installed and designated LATCH seating positions.

Most vehicles manufactured after September 2002 are equipped with lower anchor bars.

Check your vehicle owner's manual to see which seating positions may be equipped with the LATCH system.

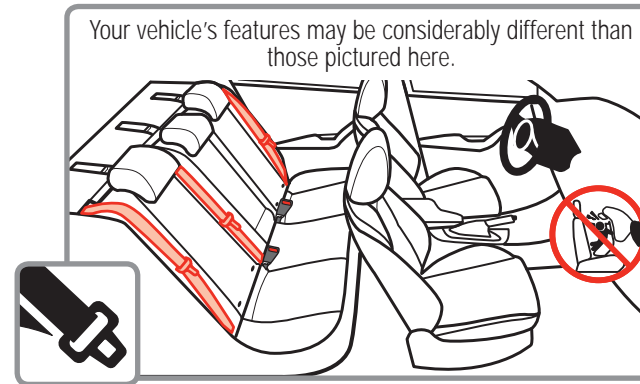

### Vehicle Belts

If lower anchors are not an option, you must use the vehicle seat belt system to install the child restraint.

There are some vehicle belts that will not work with a child restraint or will require special attention.

Check your vehicle owner's manual for specific instructions.

**⚠ WARNINGS:** When used correctly the lower anchor belt or vehicle belts are equally safe. Do not use both the lower anchor belt and vehicle belt at the same time.

## D-3 Knowing Your Vehicle Belts

Not all vehicle belts and seating positions will work with child restraints. Please follow the following steps to understand how to lock a child restraint with a vehicle belt.

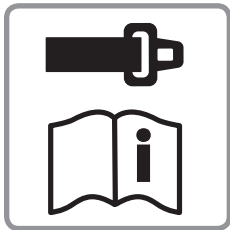

### 1. You MUST Review Your Vehicle Owner's Manual

Your vehicle owner's manual will let you know what vehicle belts and seating positions child restraints can be installed in.



### 2. Determine How the Child Restraint Will Be Locked Into Place

The vehicle belt MUST NOT loosen after a.

This means there needs to be a way to lock the vehicle belt.

The ways this can be done are:

- By using the seat belt's retractor; or
- By using the seat belt's latch plate.

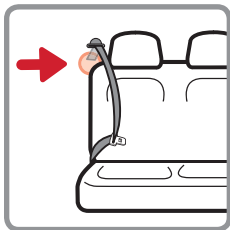

### 3. Check the Retractor

Retractors pull seat belts into stored positions and lock the belt to hold passengers in place.

A retractor is most likely how you will be locking a child restraint into place.

See the next page for some common types of vehicle belt retractors that will work with this child restraint.

## Types of Retractors

<b>Switchable Retractor</b> (most vehicles have this type)	 D. General Vehicle Information
---	---

This retractor can be switched to a locking mode.

You **MUST** have the retractor in the locking mode to use the seat belt with this child restraint.

**Switching to locking mode:** Slowly pull the shoulder belt all the way out, then let it go back in an inch or two.

As it goes back, in you will most likely hear a ratcheting sound.

Gently pull the belt to see if it has locked. You will not be able to pull any more belt out if the lock has engaged.

<b>Automatic Locking Retractor</b>	 D. General Vehicle Information
------------------------------------	---

This retractor always locks.

It will automatically lock after slowly pulling the seat belt out at least halfway and letting the belt go back into the retractor an inch or two.

<b>Emergency Locking Retractor</b>	See Step 4, "Check the Latch Plates," on next page. D. General Vehicle Information
------------------------------------	---

If the retractor does not lock, it is most likely an Emergency Locking Retractor. These retractors only lock during a sudden stop or collision.

You will need to determine if your seat belt's latch plate can lock the belt. See Step 4, "Check the Latch Plates," on next page.



#### 4. Check the Latch Plates

Latch plates are the part of the seat belt that goes into the buckle.

Hold the lap belt with one hand and with your other hand grasp the tongue of the latch plate (the part that goes inside the buckle). Pull the latch plate straight out in line with the lap belt.

If the latch plate does not slide up and down the vehicle belt, it is a **locking latch plate**.

If the latch plate slides up and down the vehicle belt, it is a **sliding latch plate**.

Sliding latch plates easily slip between the lap and shoulder portions of the belt.

If you have an Emergency Locking Retractor with a Sliding Latch Plate, you **MUST** use a locking clip to install the child restraint. See pages 52-55.

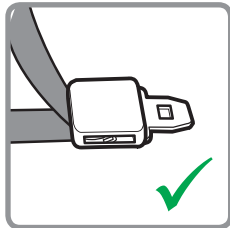

Locking Latch Plate

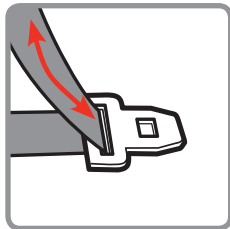

Emergency Locking Retractor with a Sliding Latch Plate

Never Use With This Child Restraint	
Emergency Locking Retractor Lap Only Belt	✗
Inflatable Seat Belts	✗

#### D-4 Aircraft Information



This restraint is certified for aircraft use.

Install the child restraint in a window seat to avoid blocking the aisle. If the aircraft lap belt is too short, ask the flight attendant for a belt extender.

Use only on forward facing aircraft seats.

Contact the airline for their specific policies.



#### Rear Facing Aircraft Installation

For rear facing without base installation follow section E-4.



Some airlines may ask to see a label stating that this child restraint is certified for aircraft use.

There is an airplane certification label located on the back of this child restraint as shown.

## D-5 Storing Lower Anchor

### **⚠ WARNING:**

Failure to securely store the lower anchor belts can result in serious injury or death.

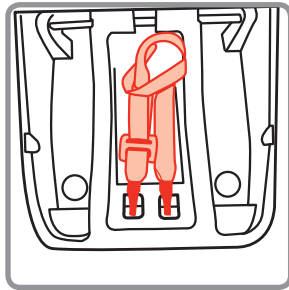

Attach Lower Anchor Hooks to Bars in Storage Location

## E-1 Rear Facing Installation with Base

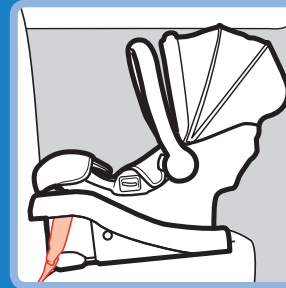

 Lower Anchor Belt

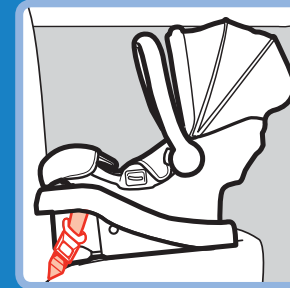

 Lap Belt

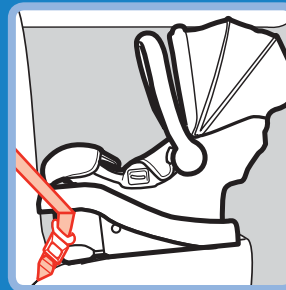

 Lap/Shoulder Belt

### **⚠ WARNING:**



Never place a child rear facing in a seating position with an active frontal airbag. This can result in serious injury or death.

This child restraint must always face the rear of the vehicle.



## E-2 Installing Base with Lower Anchor Belt

NOTE: Review your vehicle owner's manual for lower anchor belt use.

### **⚠ WARNING:**

Do not use lower anchor along with the vehicle lap or lap/shoulder belt.

Check lower anchor belt before each use. Use only if the belt can be tightened properly and securely.

Do not fasten multiple lower anchor hooks on the same lower anchor bar in the vehicle.

Failure to follow these warnings can result in serious injury or death.

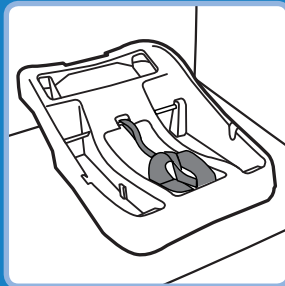

### 1. Place Base in Vehicle Rear Facing

Center the base between the vehicle anchors in the chosen seating position.

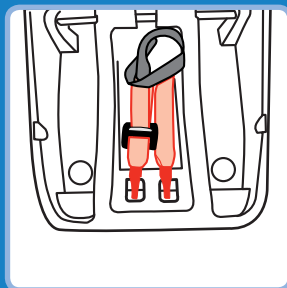

### 2. Remove Lower Anchor from Storage

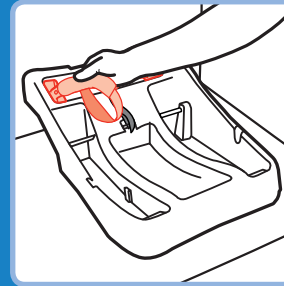

### 3. Thread Lower Anchor Belt

Thread lower anchor hooks through belt path openings.



### 4. Attach Lower Anchor Hooks to Vehicle Anchors



### 5. Tighten Belt

Push base down **FIRMLY** on the base and towards the vehicle seat while pulling up on the belt to tighten.

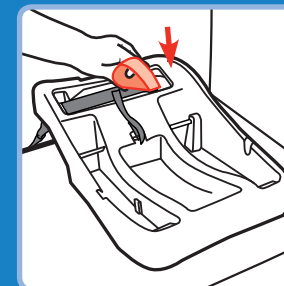

### 6. Tuck Loose End of Belt

You **MUST** tuck loose end of the lower anchor belt back through the belt path hole.

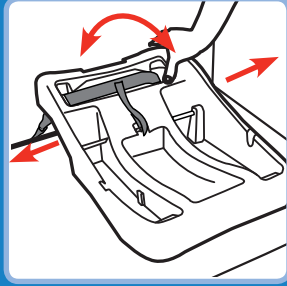

### 7. Check Belt Tightness

Grasp the base at the belt path with one hand. Push and pull the child restraint from side to side, forward and back. The child restraint should not move more than 1 in. (2.5 cm).

NOTE: If it moves more than 1 in. (2.5 cm), try reinstalling the child restraint or try another seating location.

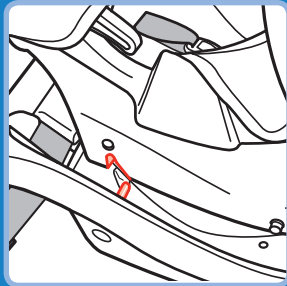

### 8. Attach Carrier to Base

**Secure child in child restraint.**

Align the notches in the front of carrier with the base lock bar.

Push down firmly to lock. You will hear a “click” when it is locked. Pull up on carrier to make sure it is locked.

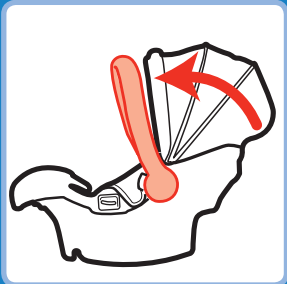

**Carry handle MUST be upright AND locked when installed in the vehicle.**

## ⚠ WARNING:

**Failure to securely attach carrier to base can result in serious injury or death.**

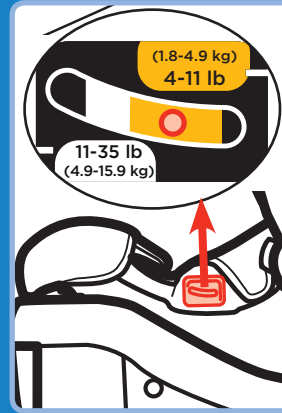

### 9. Check Angle Indicator

Check the angle indicator while parked on level ground. The ball should be in the zone that matches the weight of your child.

**Repeat steps 4-8 if not reclined correctly and adjust base if needed** (see section C-8).

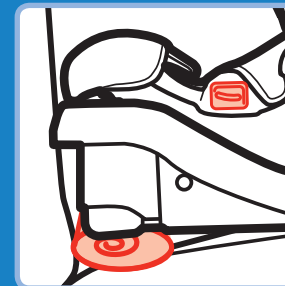

You may need to place a large rolled towel or foam pool noodles under the front of the base to achieve correct recline angle.

Check often to be sure padding is still in place and the belt is tight.



### To Remove Lower Anchor Belt From Vehicle Anchor

Remove shell from base.

Remove tension from the lower anchor belt by pushing down on side of base with the lower anchor belt adjuster. Then press the adjuster button to loosen belt.

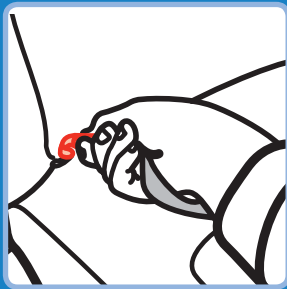

Unhook from anchor by squeezing spring lever on hook, pushing hook back into the seat bight, and twisting. Then pull it out of the vehicle seat.

Store lower anchor belt when not in use. See section D-5.



## E-3 Installing Base with Vehicle Belts

### **WARNING:**

Do not use lower anchor along with the vehicle lap or lap/shoulder belt. Store lower anchor when using the vehicle belts.

Check the vehicle belt before each use. Use only if the belt is tightened properly and securely.

Failure to follow these warnings can result in serious injury or death.

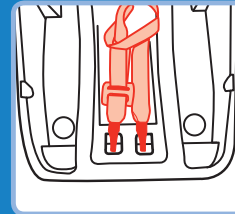

### 1. Store Lower Anchor

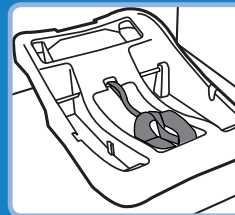

### 2. Place Base in Vehicle Rear Facing

Center the base in the chosen seating position.

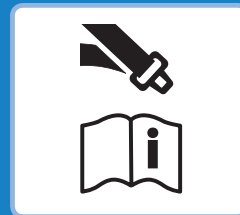

### 3. Check if Your Vehicle Belts Will Work With This Child Restraint

This is very important because not all vehicle belts will work with child restraints.

Review section D-3 and your vehicle owner's manual to determine what kind of vehicle belt you have and how to lock a child restraint in place.





**4. Thread Vehicle Belt**  
Thread the vehicle lap or lap/shoulder belt combination through belt path as shown.



**5. Tighten Belt**  
Push base down **FIRMLY** on the base and towards the vehicle seat while pulling up on the belt to tighten.

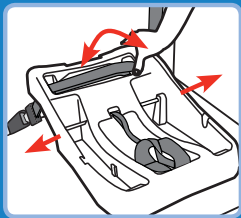

**6. Check Belt Tightness**  
Grasp the base **at the belt path with one hand**. Push and pull the child restraint from side to side, forward and back. The child restraint should not move more than 1 in. (2.5 cm).

NOTE: If it moves more than 1 in. (2.5 cm), try reinstalling the child restraint or try another seating location.

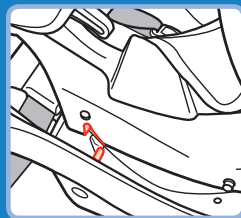

**7. Attach Carrier to Base**  
**Secure child in child restraint.**

Align the notches in the front of carrier with the base lock bar. Push down firmly to lock. You will hear a “click” when it is locked. Pull up on carrier to make sure it is locked.

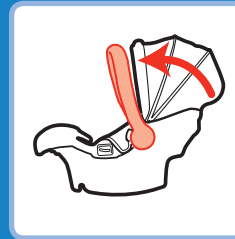

Carry handle **MUST** be upright **AND** locked when installed in the vehicle.

**⚠ WARNING:**  
**Failure to securely attach carrier to base can result in serious injury or death.**

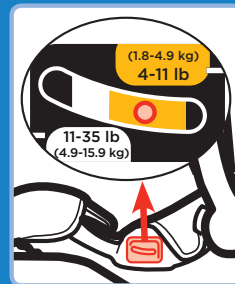

**8. Check Angle Indicator**  
Check the angle indicator while parked on level ground. The ball should be in the zone that matches the weight of your child.  
**Repeat steps 3-6 if not reclined correctly and adjust base if needed** (see section C-8).

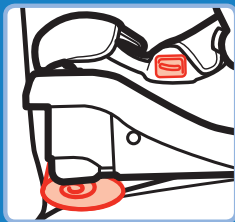

You may need to place a large rolled towel or foam pool noodles under the front of the base to achieve correct recline angle.  
Check often to be sure padding is still in place and the belt is tight.

## E-4 Rear Facing Installation without Base

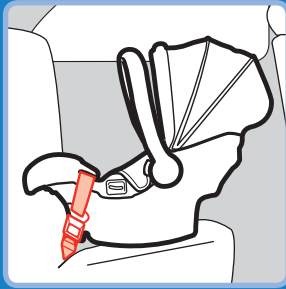

Lap Belt

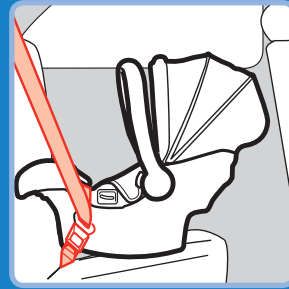

Lap/Shoulder Belt

### **⚠ WARNING:**



Never place a child rear facing in a seating position with an active frontal airbag. This can result in serious injury or death.

This child restraint must always face the rear of the vehicle.

Do not use lower anchor along with the vehicle lap or lap/shoulder belt. Store lower anchor when using the vehicle belts.

Check the vehicle belt before each use. Use only if the belt is tightened properly and securely.

Failure to follow these warnings can result in serious injury or death.



## E-5 Installing Child Restraint with Vehicle Belts

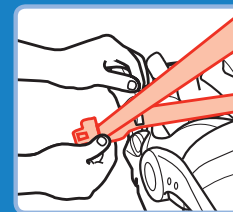
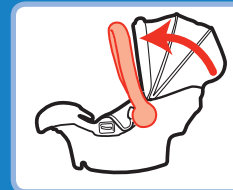
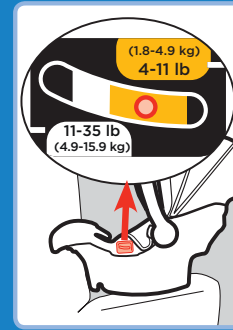

### 1. Place Child Restraint in Vehicle Rear Facing

Secure child in child restraint.

Center the child restraint in the chosen seating position.

Check the angle indicator while parked on level ground. The ball should be in the zone that matches the weight of your child.

Carry handle **MUST** be upright **AND** locked when installed in the vehicle.

### 2. Check if Your Vehicle Belts Will Work With This Child Restraint

This is very important because not all vehicle belts will work with child restraints.

Review section D-3 and your vehicle owner's manual to determine what kind of vehicle belt you have and how to lock a child restraint in place.

### 3. Thread Vehicle Belt

Thread vehicle lap belt through the belt path (as shown).

Buckle the vehicle belt.

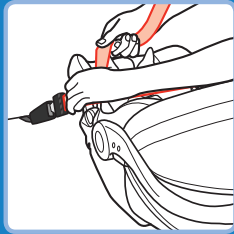

#### 4. Tighten Vehicle Belt

Lay your forearm across child restraint at the belt path while pulling up on belt to tighten.

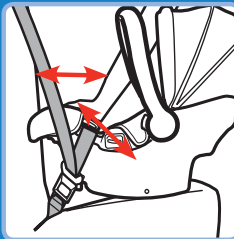

#### 5. Check Belt Tightness

Grasp the child restraint at the belt path with one hand. Push and pull the child restraint from side to side, forward and back. The child restraint should not move more than 1 in. (2.5 cm).

NOTE: If it moves more than 1 in. (2.5 cm), try reinstalling the child restraint or try another seating location.

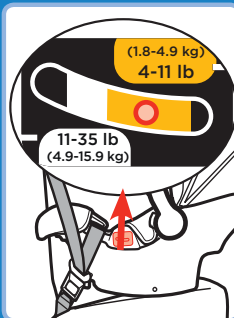

#### 6. Recheck Angle Indicator

Check the angle indicator while parked on level ground. The ball should be in the zone that matches the weight of your child.

**Repeat steps 1-5 if not reclined correctly.**

You may need to place a large rolled towel or foam pool noodles under the front of the base to achieve correct recline angle.

Check often to be sure padding is still in place and the belt is tight.

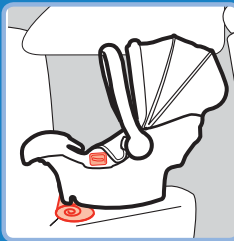

### Using a Locking Clip

You will rarely need to use a locking clip except for in some older vehicles. Built in child restraint locking systems have been required in vehicles since 1996, and many vehicles had these features even earlier.

Check your vehicle owner's manual to learn how to use the systems in your vehicle. If you need a locking clip, please go back to the store where you purchased this child restraint and purchase one or call us at 1-800-544-1108 to order one. Locking clips from any child restraint manufacturer are okay to use.

Remove the locking clip when the vehicle seat belt is not being used with the child restraint. **A locking clip will not fix all types of seat belt problems.**

Refer to section D-3 and your vehicle's owner manual to determine if your vehicle belts require a locking clip.

Directions below describe installing the child restraint without the base. Same steps apply for use on the base. See section E-3 or E-5 for vehicle belt step by step installation.

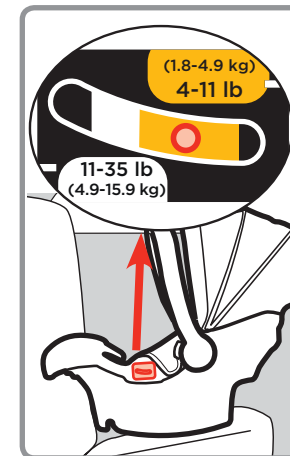

#### 1. Place Child Restraint in Vehicle Rear Facing **Secure child in child restraint.**

Center the child restraint in the chosen seating position.

Check the angle indicator while parked on level ground. The ball should be in the zone that matches the weight of your child.

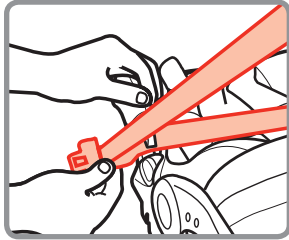

### 2. Thread Vehicle Belt

Thread vehicle lap belt through the belt path (as shown).  
Buckle the vehicle belt.

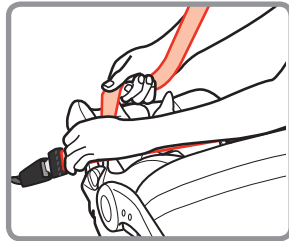

### 3. Tighten Vehicle Belt

Lay your forearm across child restraint at the belt path while pulling up on belt to tighten.

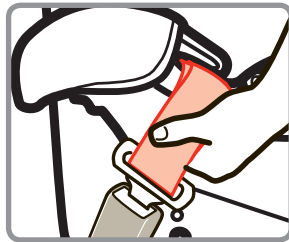

### 4. Locate Locking Clip Location

Grasp both vehicle belts together just behind the latch plate and unbuckle.  
**NOTE:** If the latch plate ends up just at the belt path opening so you

cannot grasp the vehicle belt at the latch plate, grasp the vehicle belts on the opposite side of the child restraint, as close to the latch plate as possible.

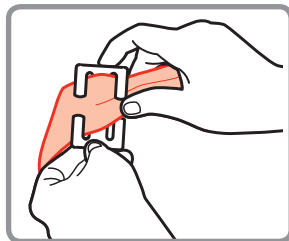

### 5. Attach Locking Clip

Thread both portions of the vehicle belt onto the locking clip, as close to the latch plate as possible.

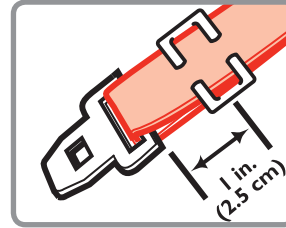

### 6. Position Locking Clip

Position locking clip about 1 in. (2.5 cm) from vehicle belt's latch plate.  
Rebuckle vehicle belt.

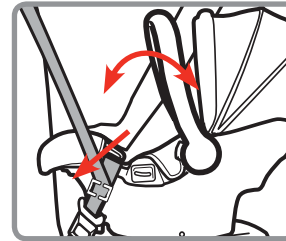

### 7. Check Belt Tightness

Grasp the child restraint **at the belt path with one hand**. Push and pull the child restraint from side to side, forward and back. The child restraint should not move more than 1 in.

(2.5 cm). **NOTE:** If it moves more than 1 in. (2.5 cm), try reinstalling the child restraint or try another seating location.

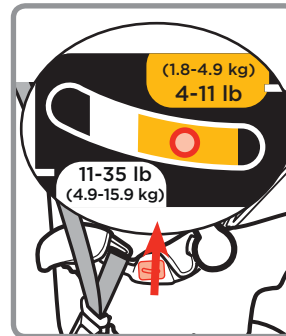

### 8. Recheck Angle Indicator

Check the angle indicator while parked on level ground. The ball should be in the zone that matches the weight of your child.

**Repeat steps 1-7 if not reclined correctly.**

You may need to place a large rolled towel or foam pool noodles under the front of the base to achieve correct recline angle.

Check often to be sure padding is still in place and the belt is tight.

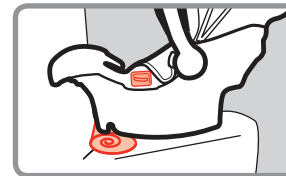

**Remove the locking clip when the seat belt is not being used with a child restraint.**

## Troubleshooting

- 1. Locate a Child Safety Seat Inspection Station for hands on training on how to use your child restraint:** Visit your local Child Passenger Inspection Station or go to <http://www.safercar.gov/cpsApp/cps/index.htm> to find your closest station.
- 2. If the child restraint buckle or harness release lever sticks or you cannot get the straps tight enough around child:** DO NOT LUBRICATE. Check around lever and retractor for dropped food, sticky spilled drinks, dirt, leaves, etc. Clean with warm water and/or remove object with tweezers. If you cannot get the harness to adjust and remain tight with the buckle securely locked, do not use the child restraint.
- 3. If your harness twists:** Straighten the harness each time you put your child in the child restraint to help prevent twisting. Lock the buckle and tighten harness so it will be ready for next use.

## Replacement Parts Order Form

Complete the form. Your model number and manufacturer date code **MUST** be included on the form to ensure proper replacement parts. The codes can be found on a label on side of child restraint. Payment in U.S. dollars must accompany your order. Choose parts needed from the list on the next page. Return the form with payment to:

**Dorel Juvenile Group, Inc.**  
**Consumer Care Department**  
P.O. Box 2609  
Columbus, IN 47202-2609

Please make money orders payable to Dorel Juvenile Group, Inc. Fill in the area on the next page to charge credit card. (Visa or MasterCard **only**). We do not accept cash, personal checks, or other credit cards. All outside of U.S. and Canada **MUST** use credit card.

**Ship To:** (Please Print)

**Name:** \_\_\_\_\_

**Address:** \_\_\_\_\_

**City:** \_\_\_\_\_

**State/Province:** \_\_\_\_\_ **Zip:** \_\_\_\_\_

**Telephone:** \_\_\_\_\_

**Email Address:** \_\_\_\_\_

We **MUST** have this information:

**Model Number (8 to 9 characters):** \_\_\_\_\_

**Manufacture Date (mm/dd/yyyy):** \_\_\_\_\_

## Replacement Parts List

**NOTE:** If requested color is not available, similar color will be substituted.

Part	Cost	Quantity	Total Cost
Buckle .....	\$6.99	X _____	= \$ _____
Harness Strap.....	\$2.00	X _____	= \$ _____
Pad Set .....	\$27.50	X _____	= \$ _____
Chest Clip.....	\$1.50	X _____	= \$ _____
Locking Clip.....	\$2.50	X _____	= \$ _____
Base .....	\$39.99	X _____	= \$ _____
Instructions.....	\$0.00	X _____	= \$ _____

Merchandise Total \$ \_\_\_\_\_

Shipping and handling: \$ \_\_\_\_\_

Up to \$25.00.....	\$5.95	\$100.01 to \$150.00 .....	\$10.95
\$25.01 to \$50.00 .....	\$6.95	\$150.01 to \$200.00 .....	\$11.95
\$50.01 to \$75.00 .....	\$8.95	\$200.01 and up .....	\$13.95
\$75.01 to \$100.00 .....	\$9.95	Outside Continental USA	\$10.00

Sales Tax \$ \_\_\_\_\_  
 (Arizona, California, Georgia, Indiana, Missouri, South Carolina, and Texas residents add applicable sales tax.)

Grand Total \$ \_\_\_\_\_

No shipping and handling on instructions for quantities under 6. Add \$.50 for each instruction over 6, then add applicable shipping and handling.

Fill Out For Credit Card  
 Visa  Mastercard

Card Exp. Date: \_\_\_\_\_

Cardholder's Name: \_\_\_\_\_

Card Number: \_\_\_\_\_

Signature \_\_\_\_\_

## Warranty

Dorel Juvenile Group, Inc. (DJG) warrants this product to the original retail purchaser as follows:

This product is warranted against defective materials or workmanship for one year from the date of original purchase. **An original receipt is required to validate your warranty.** DJG will, at its option, provide replacement parts or replace this product. DJG reserves the right to substitute if the part or model has been discontinued.

To make a claim under this warranty you may write to DJG, Consumer Care Department, P. O. Box 2609, Columbus, IN 47202-2609; or call 1-800-544-1108 from 8:00 a.m. to 6:00 p.m. EST Monday through Thursday and from 8:00 a.m. to 4:30 p.m. on Friday.

**Proof of purchase is required and shipping charges are the responsibility of the consumer.**

**Warranty Limitations:** This warranty does not include damages which arise from misuse or abuse of this product.

**Limitation of Damages:** The warranty and remedies as set forth are exclusive and in lieu of all others, oral or written, expressed or implied. In no event will DJG or the dealer selling this product be liable to you for any damages, including incidental or consequential damages, arising out of the use or inability to use this product.

**Limitation of warranties and other warranty terms and state law rights:**

Any implied warranties, including implied warranties of the merchantability and fitness for a particular purpose, shall be limited to the duration and terms of the express written warranty. Some states do not allow limitations as to how long an implied warranty lasts or the exclusion or limitation of incidental or consequential damages, so the above limitations may not apply to you.

This warranty gives you specific legal rights, and you may have other rights, which vary from state to state. Neither DJG nor the dealer selling this product authorized any person to create for it any other warranty, obligation, or liability in connection with this product.

CUT ON DOTTED LINE