

## Convertible Car Seat

INFANT SEAT TO BOOSTER SEAT  
CS4313



Infant Seat

Child Car Seat

Booster Seat

- (Rearward Facing) Suitable for children from birth to approximately 12 months\* of age.
- (Forward Facing) Suitable for children from 12 months of age to approximately 4 years\* of age.
- (Booster Seat) Suitable for children from 4 to 8 years\* of age.

## Instruction Manual

### **IMPORTANT**

**KEEP THIS BOOKLET IN THE PLACE PROVIDED ON THE CHILD RESTRAINT.**

All references to age are to an average proportioned child. Children vary in shapes and sizes. The ages above is an approximation only.

The photo displayed is indicative of the type of restraint and may vary slightly depending on the model.



**Australian  
Standard**

AS/NZS: 1754:2013  
Licence No. 25324-1  
SAI Global

# Contents

Contents	1
Information	2
Warnings	3
Restraint Guide	5
Padding - Combination Guide	6

## Infant Seat

Information	7
CS4313 Child Restraints (Itemised list)	9
Shoulder Height Marker	10
Set Up	
- General	11
- Selection of Appropriate Padding Combination	12
- Converting to Infant Seat	12
- Recline Angle	14
- Shoulder Height	15
- Adjusting the Headrest	15
- Shoulder Height Slot Selection	17
Installation	
- Installing using Vehicle seatbelt	18
Use	
- Using Inbuilt Harness	22
- To Release Child	25

## Child Seat

Information	26
CS4313 Child Restraints (Itemised list)	29
Shoulder Height Marker	27
Set Up	
- Selection of Appropriate Padding Combination	30
- Converting to Infant Seat	30
- Shoulder Height	31
- Adjusting the Headrest	31
- Shoulder Height Slot Selection	33
Installation	
- Installing using Vehicle seatbelt	34
Use	
- Using Inbuilt Harness	38
- To Release Child	40

## Booster Seat

Information	41
CS4313 Child Restraints (Itemised list)	42
Shoulder Height Marker	43
Next Restraint	
- Next Type of Restraint	45
- Five Step Test	45
Set Up	
- Selection of Appropriate Padding Combination	46
- Converting to a Child Booster	46
- Adjusting the Headrest	48
- Installing in Vehicle	49
Use	
- Using lap-sash belt	51
- Sash Guide	53
- To Release Child	54
Care of Restraint	
- Care and Maintenance	55
- Cleaning	57
Remove & Replace Covers	58
Extension Straps	59
Accessories	60
Anchorage Fittings	63
Insurers Information	66
Notes	67
Lifetime Warranty	70

# Information

This instruction manual covers various models under the Model number CS4313. These child restraints are installed in the rear of the vehicle and can be used either rearward-facing, forward-facing or booster seat. They are installed in the vehicle using the vehicle seatbelt & the top tether strap. This Convertible Car Seat is designed to be used by children from approximately 0 months of age up to approximately 8 years of age.

## **Air Cocoon Technology™ - A Protective Embrace**

Air Cocoon Technology™ (A.C.T.) enhances protection by dramatically reducing the impact forces during a crash. A.C.T. utilises a layer of air held inside the entirety of the child restraint shell, offering an increased level of protection across the entire surface area of the restraint. Your child is quite literally cradled in a cocoon of air, offering a true 180 degrees of protection to your child's vital organs.



## **Secur-air**

Secur-air works hand in hand with Air Cocoon Technology to dramatically reduce crash energy to the child's head. Together they reduce crash energy more than five times lower than the level required by the Australian Standard.



**secur-air™**

## **Child Restraints**

No child restraint can guarantee absolute protection from injury in every crash. However, to ensure that your child gets all the protection designed into the restraint please read and follow the instructions exactly and use only InfaSecure recommended parts and accessories.

## **Family Bussiness**

InfaSecure is an Australian owned and operated family business, which can trace it's roots back over 60 years in business, becoming the single largest Australian owned and operated child restraint company in the country. Today, we are still growing, continuing to innovate and provide high quality products at an affordable price.



# Warnings



## WARNING

- Use the restraint exactly as shown in the instructions.
- Supervision of children is needed because they may be able to undo buckles.
- **DO NOT LEAVE CHILDREN UNATTENDED IN THE CAR.**
- Do not alter or modify this restraint.
- Repairs must only be done by the manufacturers or agent.
- Do not allow the restraint to come into contact with polishes, oils, bleach and other chemicals.
- Destroy the restraint if it has been in a severe crash, even if no damage is visible.
- **DO NOT USE THIS RESTRAINT WITHOUT THE COVER.**
- To ensure infant's back is evenly supported, do not put more than one nappy on the baby and make sure the nappy is not thickly folded at the back.
- **DO NOT USE A REAR-FACING CHILD RESTRAINT WHERE AN AIRBAG IS FITTED IN FRONT OF THE SEATING POSITION.**
- Fit the restraint firmly to the car seat.
- Fit the harness firmly to the child.
- A loose restraint or harness is dangerous.
- Do not harness an infant wrapped in a blanket or swaddled. Any blanket or wrap must only be placed over the harness and infant.
- Always secure the loose end of the top tether strap. Do not use the child restraint where this strap may fall into a split in the seat back or off the side of the seat.
- **ALWAYS ATTACH HOOK AND REMOVE SLACK.**



## IMPORTANT

Please read carefully the whole of the instructions for installation and, in the event of doubt about the method of installation, to consult InfaSecure or agent, or a child restraint fitter, or in New Zealand, to consult the agent for the vehicle.

# Warnings



## WARNINGS

- THIS RESTRAINT IS NOT SUITABLE FOR USE WHERE THE TOP TETHER STRAP MAY FALL INTO A SPLIT IN THE SEAT BACK OR OFF THE SIDE OF THE SEAT.
- THIS RESTRAINT MUST BE ATTACHED TO A CHILD RESTRAINT UPPER ANCHORAGE POINT IN THE CAR. REFER TO CAR OWNER'S HANDBOOK FOR LOCATION OF ANCHORAGE POINTS. REFER TO A CHILD RESTRAINT FITTING STATION IF NO ANCHORAGE POINTS ARE IN THE MOTOR CAR.
- Always secure the loose end of the top tether strap to prevent it hanging out of the car or being accessible by the child. Do not use the child restraint where this strap may fall into a split into the seat back or off the side of the seat.
- IF AN AIRBAG IS FITTED IN THE SEATING POSITION WHERE THE CHILD RESTRAINT IS TO BE FITTED, FOLLOW THE VEHICLE MANUFACTURER'S WARNINGS AND INSTRUCTIONS.
- THIS CHILD RESTRAINT IS NOT APPROVED FOR USE WITH ANY CONNECTORS THAT CONNECT TO THE CARS ISOFIX LOW ANCHORAGES.



## WARNING

**DO NOT LEAVE CHILDREN UNATTENDED IN THE CAR.**



## IMPORTANT

There is a real potential for an infant to be ejected and killed if the baby is wrapped in a blanket or swaddled. The harness needs to fit the baby firmly and any blanket or other covering may only be placed over the harness after the harness is adjusted firmly. Please ensure the baby's arms and legs are not bound or wrapped together.

# Restraint Guide

MODE	Infant Seat		Child Seat		Booster Seat		Seat Belt	
	BIRTH	2	4	6	7	8	10	12+
<b>REARWARD-FACING RESTRAINT (TYPE A1)</b> BIRTH TO APPROX 6 MONTHS	REARWARD FACING 0 to 6 (months)							
<b>CONVERTIBLE CAR SEAT (TYPE A2/B)</b> BIRTH TO 4 YEARS	REARWARD FACING	FORWARD FACING		Approx 0 to 4 years				
<b>CONVERTIBLE CAR SEAT (TYPE A4/B)</b> BIRTH TO 4 YEARS	REARWARD FACING		FORWARD FACING	Approx 0 to 4 years				
<b>ZERO TO 8 CONVERTIBLE CAR SEAT (TYPE A2/B/E)</b> BIRTH TO 8 YEARS	REARWARD FACING	FORWARD FACING		BOOSTER SEAT			Approx 0 to 8 years	
<b>FORWARD-FACING RESTRAINT (TYPE B)</b> APPROX 6 MONTHS TO 4 YEARS	FORWARD FACING			Approx 6 months to 4 years				
<b>FORWARD-FACING RESTRAINT (TYPE G)</b> APPROX 6 MONTHS TO 8 YEARS	FORWARD FACING						Approx 6 months to 8 years	
<b>CONVERTIBLE BOOSTER SEAT (TYPE B/E)</b> APPROX 6 MONTHS TO 8 YEARS	FORWARD FACING			BOOSTER SEAT			Approx 6 months to 8 years	
<b>BOOSTER SEAT (TYPE E)</b> FROM APPROX 4 YEARS TO 8 YEARS			Approx 4 years to 8 years	BOOSTER SEAT			LARGER BOOSTER SEAT	
<b>BOOSTER SEAT (TYPE F)</b> FROM APPROX 4 YEARS TO 10 YEARS			Approx 4 years to 10 years	BOOSTER SEAT				
<b>SEAT BELT</b> FROM APPROX 7 YEARS AND OVER							7 +	10 +

REQUIRED BY LAW

Allowable by law

More Appropriate

**IMPORTANT:** Research has shown that the likelihood of an accessory child safety harness being used incorrectly is very high and the risk of injuries when incorrectly used is much higher compared to a lap-sash seat belt. InfaSecure recommend that an accessory child safety harness should only be used if a lap-only seat belt is all that is available.

# Warnings

## Combination Guide



Insert

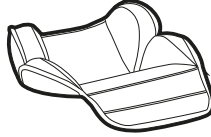

Mode

**INFANT SEAT**

(Small Infant)

**REARWARD FACING**



**INFANT SEAT**



**REARWARD FACING**

+

**FORWARD FACING**



**CHILD SEAT**

**BOOSTER SEAT**

**FORWARD FACING**

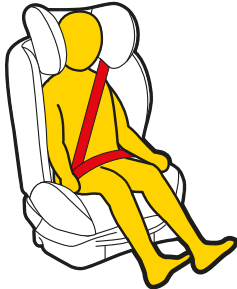

The Padded Insert/s (if fitted) are designed to provide extra support and comfort for small babies. Discontinue use when the insert is a tight fit or creates discomfort for larger babies/children.

Diagrams are indicative of type of paddings and inserts and may not resemble the actual product.

Padded inserts can vary according to model.

We reserve the right to alter this product without notice.

\*For detailed description and method of attachment for padded accessories refer to Accessories on page 60.

# Infant Seat

## Rearward Facing

### THE SUITABILITY OF THE CHILD RESTRAINT TO GROUPS OF CHILDREN

#### TYPE A2

To be used only in a rearward-facing position with built-in harness until the infant's shoulders reach the lower shoulder height marker (approximately 12 months of age).

#### TYPE B

Then to be used in a forward-facing position with built-in harness until the child's shoulders are above the middle shoulder height marker (approximately 4 years of age).

#### TYPE E

Finally, to be used with a lap-sash seatbelt until the child's shoulders reach the upper shoulder height marker (approximately 6 to 8 years of age).

Continue to use this child restraint until the child reaches this limit

Do not use forward-facing until child's shoulders are above the lower shoulder height marker.

Infants are at risk of serious injury if they face forward too early.

If the child's knees do not bend in front of the vehicle seat cushion, continue to use a booster seat.

Children are safest in the child restraint in the booster seat mode until their shoulders reach the upper shoulder height marker of the booster seat.

Just using a seatbelt is not recommended for children that have outgrown this seat. Use a larger booster seat.

**TO BE USED WITH A LAP-SASH/LAP-ONLY SEATBELT IN THE BACK OF MOST CARS WITH FORWARD FACING SEATS.**

The use of child restraints in the front seat may be restricted for children of specific ages by local legislation. Please check with your local Department of Transport for the specific seating locations of children using child restraints for their given ages.

## **IMPORTANT**

- For a vehicle without a fixed parcel shelf an extension strap(s) may be needed. If so ring (02) 4728 8090 for nearest supply location.
- Seatbelt extenders are not recommended to be used if the seatbelt is not long enough to secure the child restraint. If seatbelts are too short then advice should be sought from a child restraint fitter and their recommendation be considered before using a seatbelt extender.



# Infant Seat

## Rearward Facing

### **IMPORTANT**

- ONLY USE RESTRAINT REARWARD-FACING and in accordance with these instructions.
- Do not use the restraint without the upper anchorage strap correctly attached.
- DO NOT USE A REAR-FACING CHILD RESTRAINT WHERE AN AIRBAG IS FITTED IN THE FRONT OF THE SEATING POSITION.
- Do not use on any vehicle seat which faces sideways or rearward. Do not use excessively upright or reclined.
- For a vehicle without a fixed parcel shelf, an extension strap(s) may be needed.
- If so, ring (02) 4728 8090 for nearest supply location (refer to Page 63).
- Seatbelt extenders are not recommended to be used if the seatbelt is not long enough to secure the child restraint. If seatbelts are too short then advice should be sought from a child restraint fitter and their recommendation be considered before using a seatbelt extender.

### **IMPORTANT MESSAGE**

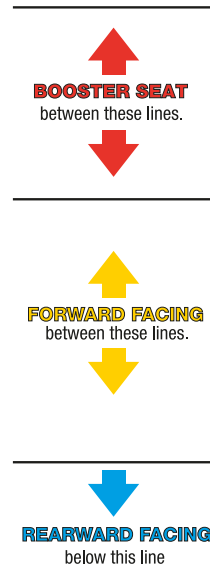

InfaSecure recommends to use this restraint, as long as possible in each mode.

# Model CS4313

## Rearward Facing

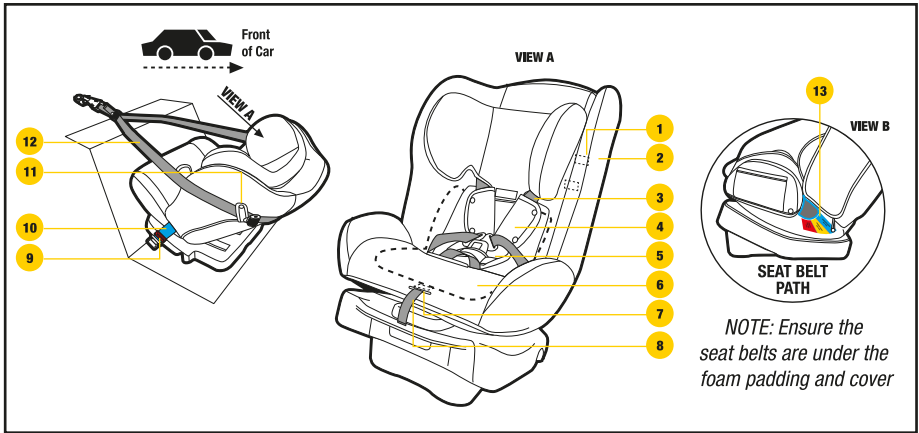

1. Shoulder Height Markers
2. Cover
3. Harness Straps
4. Shoulder Pads
5. Buckle Pad
6. Padded Insert (if fitted)
7. Harness Adjuster
8. Harness Adjustment Strap
9. Safe Grip Red Belt Clamp (if supplied with restraint)
10. Vehicle Seat belt
11. Top Tether Guide
12. Top Tether Assembly
  - Tether Strap
  - Adjuster
  - Attachment Clip
  - Anchor Fitting + Attachment Hardware
13. "REARWARD-FACING SEAT BELT PATH" Marker (each side of restraint - coloured blue)

**NOTE:** Padded inserts can vary according to model. For detailed description and method of attachment for padded accessories refer to Accessories on page 60-62.

# Shoulder Height Markers

## Baby (Rearward Facing Mode)

Shoulder height markers are provided on this restraint for a visual indication that the child is safe to travel in this restraint.

*Do not turn to forward facing until the child's shoulder reaches the lower label.*

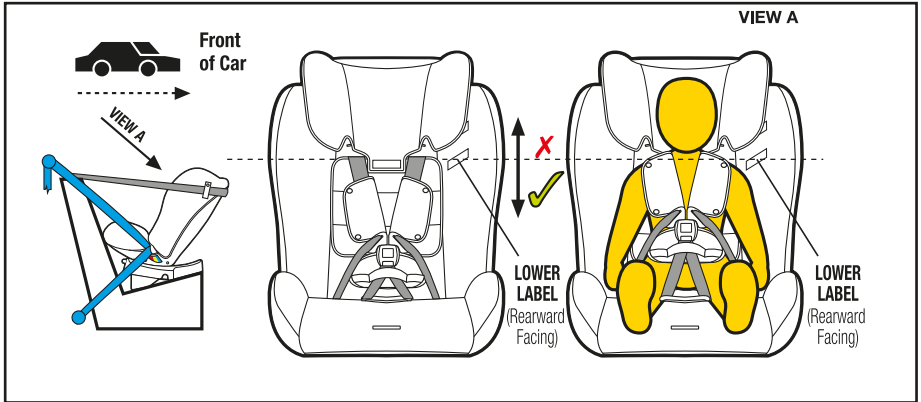

To be used only in a rearward-facing position for an infant until their shoulders **REACH** the Lower shoulder height marker (approximately 12 months of age).

LOWER LABEL (Rearward-Facing)

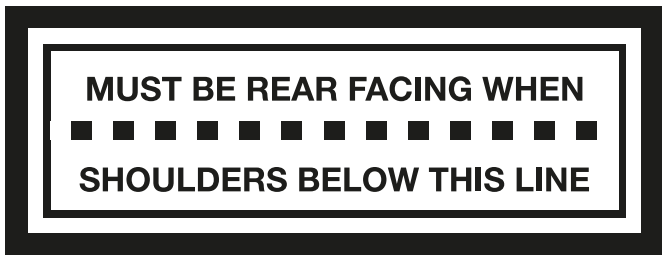

### **IMPORTANT**

Ensure that you continue to use this child restraint in rearward facing positions whilst the infants shoulders are below this shoulder height marker (Lower label).

Infants are at risk of serious injury if they face forward too early.

If the infants shoulders are below the lower label or if the baby's neck muscles are unable to support their head, then the infant should remain rear facing. When the child's shoulder reaches the lower label, the child restraint may be turned to face towards the front of the car (refer page 26 Child Seat section).

# Set Up

## General

- The CS4313 Child restraint has been designed and tested to meet the joint Australian/ New Zealand Standard with an inbuilt anti rebound feature and does not require additional anti rebound bars or mechanisms to fulfil these requirements.
- The CS4313 Child restraint has also been designed to be a compact restraint to enable multiple restraints to be used in the rear of most vehicles.

### **IMPORTANT**

- Care and attention should be given to ensure that the baby has adequate ventilation and shading when in the restraint.
- To achieve the necessary distribution of deceleration forces during a vehicle impact, ensure the child is seated correctly in the child restraint and the harness is fitted and adjusted as per these instructions.
- Ensure the child restraint and child are rearward facing.

If the baby's neck muscles are unable to support their head, then the infant should remain rear facing.

The Purchaser should check the measurement between the front of the seat back of the rear seat and all front seats in the car in which the child restraint is intended to be used, to ensure that the space is sufficient.

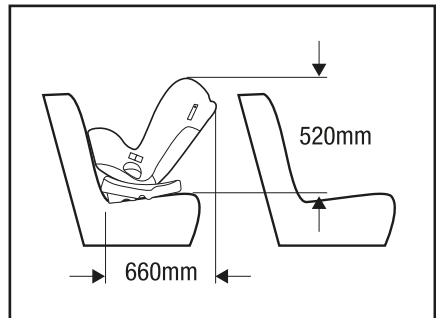

### **WARNING**

- ONLY USE RESTRAINT IN REARWARD-FACING MODE WITH "RECLINE SECTION" SWUNG FORWARD AND RESTRAINT FULLY RECLINED.
- Do not use the restraint without the upper anchorage strap correctly attached.
- DO NOT USE A REAR-FACING CHILD RESTRAINT WHERE AN AIRBAG IS FITTED IN THE FRONT OF THE SEATING POSITION.
- Do not use on any vehicle seat which faces sideways or rearward.

# Set Up

## Selection of Appropriate Padding Combinations

**Step 1:** Determine whether your infant/child requires the additional padding provided with this restraint, to ensure a safe and snug fit in the restraint. Refer to page 6 for suggested padding combinations.



### WARNING

- To ensure baby's back is evenly supported, do not put more than one nappy on the baby and make sure the nappy is not thickly folded at the back.

## Converting to Infant Seat

### Reclined Position

**Step 1:** At the front of the restraint is a red lever. Pull red lever forward and recline the seat base as far as possible.

**Step 2:** Ensure the recline section is swung forward.

**Step 3:** Ensure the In-built harness "Shoulder straps" are positioned in the appropriate slots.



### IMPORTANT

- Refer to the shoulder height labels (As shown on page 10).
- For correct shoulder strap slot height refer to pages 15-16.

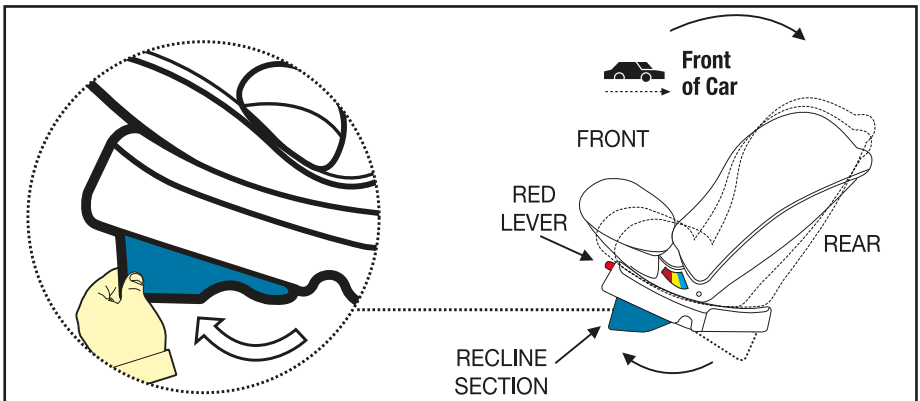

# Set Up

## Converting to Infant Seat

### Adjust assembly location

The position of the Adjuster (Top Tether strap) is adjustable for ease of installation and ease of use.

#### Rearward Facing (Type A)

**Step 1:** Pull adjuster and strap to extend the location of the adjuster assembly (refer Figure 1).

**Step 2:** Continue to extend until the adjuster has reached the desired location at the side of the restraint (refer Figure 2).

**Step 3:** Locate the adjuster at the side of the restraint and secure using the Top Tether Strap Guide (refer Figure 3).



### IMPORTANT

**EASE OF USE:** It is recommended to position the adjuster at the side of the restraint which is towards the access door (rear passenger side).

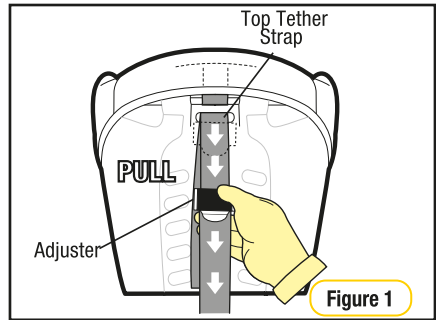

Figure 1

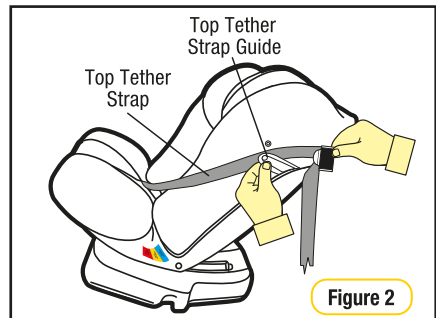

Figure 2

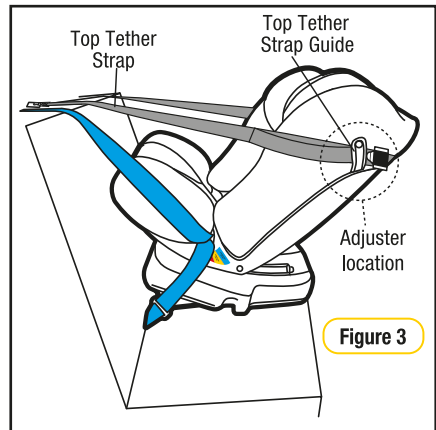

Figure 3

# Set Up

## Recline Angle

The vehicle installation is controlled by the angle of the vehicle seat, and these angles vary greatly between vehicles. The vehicle seat angle or the contours of the vehicle seat could place the child restraint either too upright or too recline. A rearward facing restraint should always be installed so that the back surface is reclined just enough to allow the infant's head to lie back comfortably, but not more than 45° from vertical. This measurement is taken when your infant is laying in the child restraint and is in direct contact with this back surface, so it's extremely import to maintain the required angle.

### **IMPORTANT**

Your infant should NEVER be too upright or too recline.

**TOO UPRIGHT** (less than 35° from vertical) could lead to the infants head flopping forward and potentially pinching off the airway.

**TOO RECLINED** (greater than 45° from vertical) could lead to the infants body sliding 'up' towards the top of the restraint. Which could promote a compressive load on the spine and/or an extension load on the neck.

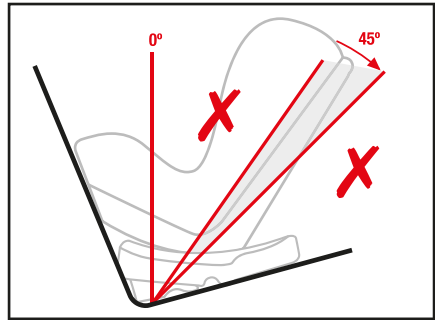

**NOTE:** An accurate method of measuring the recline angle of your infant is to use a smart phone with an application that can measure angles, but if using this method ensure the car is on a level surface.

# Set Up

## Shoulder Height

The correct height for the shoulder straps is very important for the optimum performance of the restraint.

With the child correctly sitting in the restraint, check which set of slots (in the plastic shell of the restraint) are level with or just above the infant's shoulders.

If the harness straps are located in those slots, then you can proceed with using the restraint (see section "USE" on page 22). If not then adjust the shoulder straps (refer page 17).

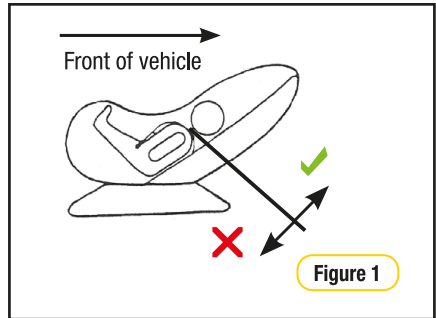

### IMPORTANT

The shoulder straps must be in the slots which are nearest to the child's shoulders, but not be lower than the child's shoulders.

## Adjusting the Headrest

The headrest can be adjusted to different heights to best suit your child. The headrest has a locking nut on the rear of the restraint.



### IMPORTANT

Refer to shoulder height marker (As shown on page 10). For the correct shoulder strap slot height refer to pages 15-17.

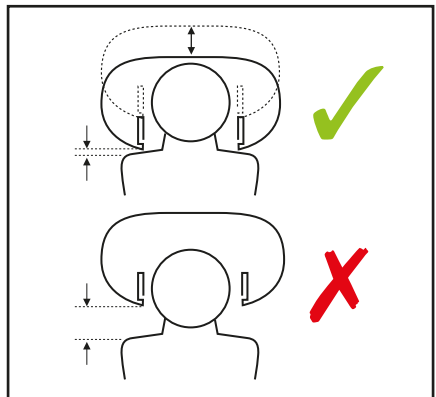



# Installation

## Adjusting the Headrest cont...

**Step 1:** Undo the adjustment nut which is located at the back of the restraint, to move the headrest either up or down (refer Figure 1).

**Step 2:** Adjust the headrest height so that the bottom of the headrest is located level with or just above the child's shoulder (refer Figure 2).

**Step 3:** Once the headrest is in the correct position tighten the adjustment nut and check the headrest is locked into place.

**Step 4:** Check to sight the location of the appropriate shoulder slots (in main shell), refer Figure 3.

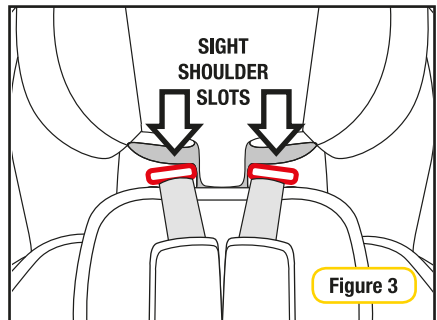
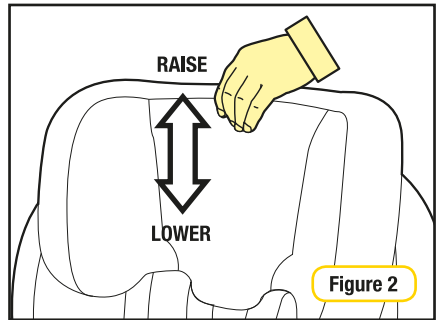
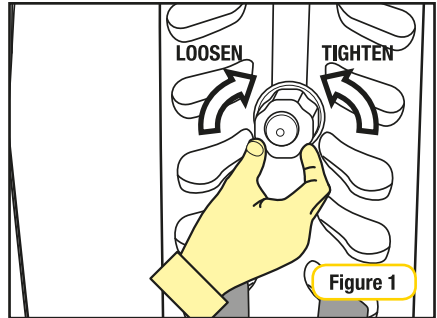

# Set Up

## Shoulder Height Slot Selection

**Step 1:** Loosen harness to allow spreader plate to rise from under the restraint. Turn the restraint so that the back of the seat is facing you.

**Step 2:** Remove each shoulder harness through the gates in the spreader plate (see Figure 1 & 4).

**Step 3:** Pull the shoulder harness straps through the shoulder slot holes in the seat body and cover. They are now loose in the front of the seat.

**Step 4:** Push the ends of the shoulder harness straps through the appropriate shoulder slot holes in the cover and seat body for the child's shoulder height.

**NOTE:** Ensure the harness straps are not twisted.

**Step 5:** The shoulder harness straps go directly from the shoulder slot holes to the spreader plate. Thread each shoulder harness strap back onto the metal spreader plate through the gate (see Figure 4).

### **IMPORTANT**

- The shoulder straps must be in the slots which are nearest to the child's shoulders, but not lower than the child's shoulders.
- Always adjust the height of the shoulder straps as the child grows

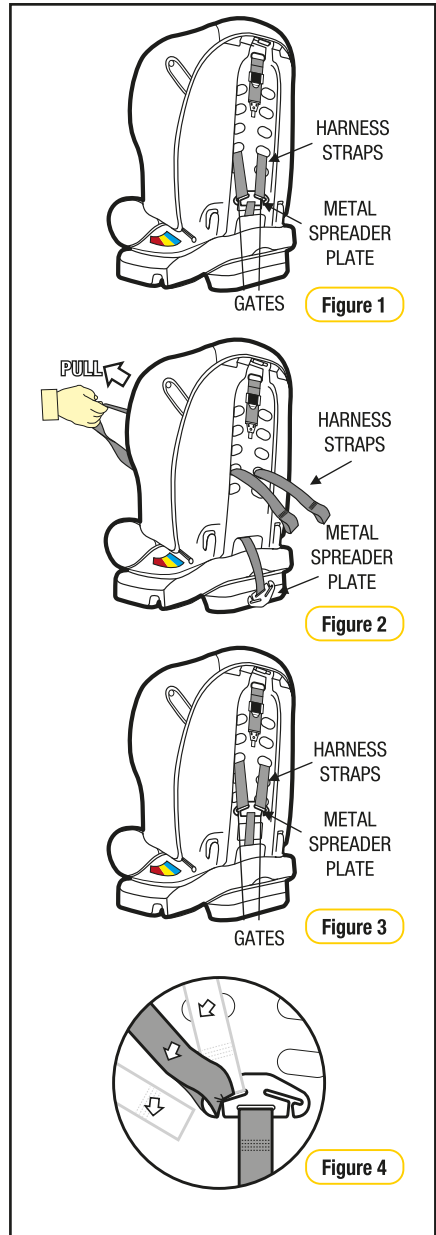

# Installation

## Installing Using Vehicle Seatbelts

**Step 1:** Place the child restraint on the vehicle seat. Ensure recline section is swung forward and the restraint is fully reclined with the restraint directly in line with anchorage point.

**Step 2:** Make sure Top Tether strap is as in illustration (Figures 1 and 2) i.e. positioned around restraint back.



### IMPORTANT

Ensure that you use the **REARWARD-FACING BELT PATH** indicators, marked in "blue".

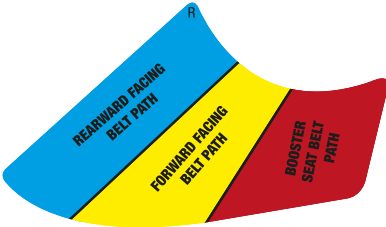

**Step 3:** Feed adult lap or lap/sash belts through the belt path opening, ensure the seat belt is under the cover & between the layer of foam and the plastic seat base.

Engage the buckle and tongue assembly (listen for a "CLICK"). Check the buckle engagement with a gentle pull.

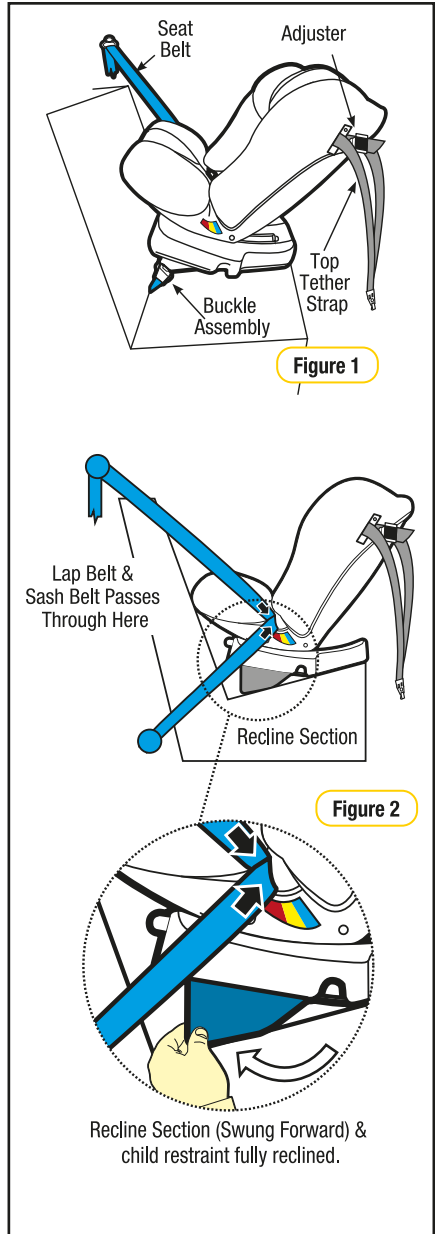

# Installation

## Installing Using Vehicle Seatbelts

**Step 4:** Push down on the base of the restraint (with knee or hand) whilst pulling the sash section of the vehicle belt firmly up in direction of the blue arrow in Figure 4. (This will tighten the lap belt across the seat base).

**Step 5:** Ensure the excess slack in the sash belt, is fed back towards the seat belt.

### Safe Grip (if supplied)

\* The Safe Grip may not be supplied with all models. It can be purchased separately; visit <http://store.infasecure.com.au>

### SAFE GRIP BELT CLAMP

The Safe Grip (red belt clamp) **locks the lap belt** to ensure a firm installation, and avoids slack in the lap belt.

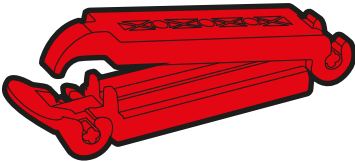

To install the **Safe Grip** (red belt clamp), open it and clamp the “sash section” ONLY of the vehicle seat belt by closing the barrel section of the red belt clamp in the direction of arrow 1 in Figure 5 and then locking with the toggle section by pushing in the direction of arrow 2 in Figure 5 when the **Safe Grip** (red belt clamp) is secured in place, the lap section is now tightly holding your child restraint in place, independent of the sash section. The **Safe Grip** (red belt clamp) must be removed when the child restraint is not installed to allow other users to use the seat belt as a lap/sash seat belt. Always keep the **Safe Grip** (red belt clamp) in pocket provided when not in use.

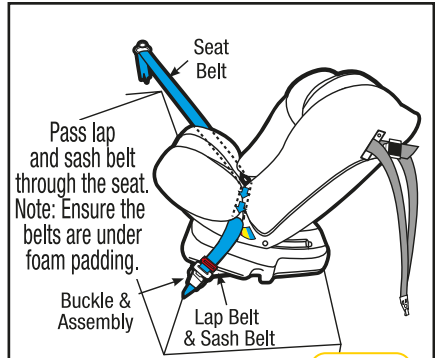
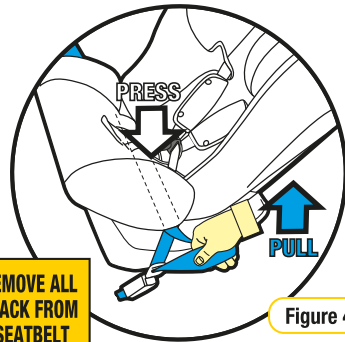

Figure 3



REMOVE ALL SLACK FROM SEATBELT

Figure 4

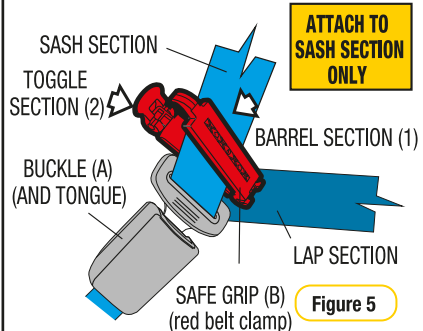

Figure 5

# Installation

## Installing Using Vehicle Seatbelts

**Note:** If no upper anchorage fitting is available refer to pages 62-64.

**Step 5:** Locate the adjuster at the side of the restraint and secure using the Top Tether Strap Guide (refer Figure 6 & 7).

**Step 6:** Hook the attachment clip to the upper anchor fitting (refer Figure 8).

### **IMPORTANT**

- The purchaser should check the measurements between the front of the seat back of the rear seat and all front seats in the car in which the child restraint is intended to be used, to ensure that the space is sufficient.
- Care and attention should be given to sufficient ventilation and shading of the baby. Always secure the loose end of the top tether strap to prevent it hanging out of the car or being accessible by the child.

### **WARNING**

- DO NOT USE REAR FACING CHILD RESTRAINT WHERE AN AIRBAG IS FITTED IN FRONT OF THE SEATING POSITION.
- Fit the restraint firmly to the car seat.
- THIS TETHER STRAP MUST ALWAYS BE FITTED WHEN THE CHILD RESTRAINT IS USED IN A VEHICLE.

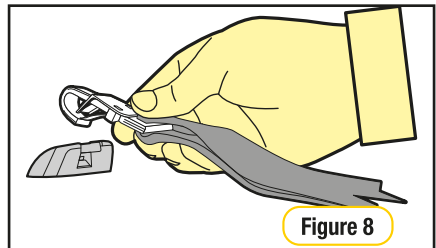
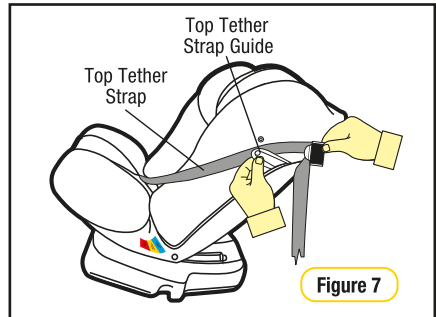
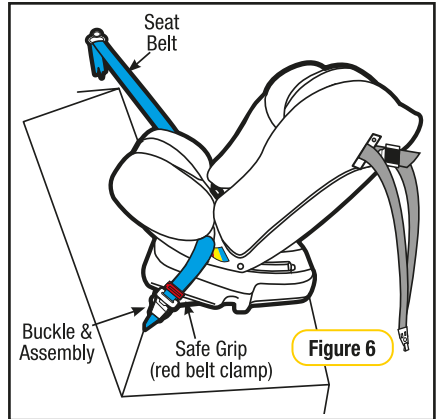

**Step 7:** Pull to tighten to remove all the slack, from the upper anchorage strap. Do not overtighten as this could cause the restraint to lift off the vehicle seat (refer to Figure 9).

# Installation

## Installing Using Vehicle Seatbelts



### IMPORTANT

- Tighten till slack is removed.
- In certain vehicles an extension strap may be needed.
- Do not overtighten Top Tether strap.
- Ensure Top Tether strap is passed through the Top Tether Strap Guide.

## Tether Storage

After correctly installing the restraint in your car, roll up and place any excess tether strap in the storage pocket provided (refer Figure 10).

### NOTE

FOLLOWING THE INSTALLATION OF THE CHILD RESTRAINT A SMALL AMOUNT OF MOVEMENT IS DEEMED ACCEPTABLE.

**CAUTION: CHILDREN CAN BE INJURED OR RESTRAINTS AND TOP TETHER STRAP DAMAGED BY UNSECURED CARGO IN A COLLISION. SECURE OR REMOVE HAZARDOUS CARGO BEFORE USING THIS CHILD RESTRAINT.**

Always secure the loose end of the top tether strap to prevent it hanging out of the car or being accessible by the child.

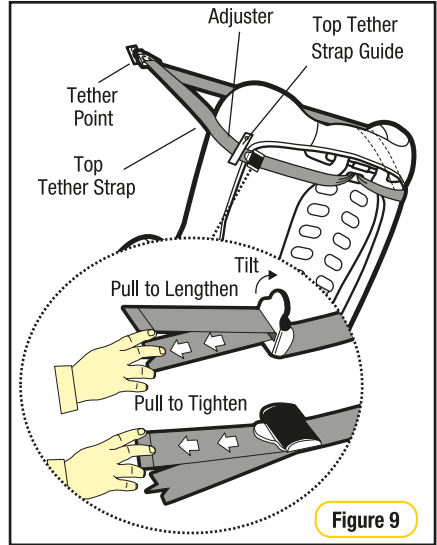

Figure 9

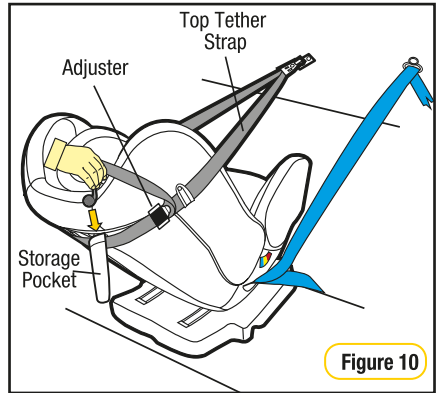

Figure 10

# Use

## Using Inbuilt Harness

**Step 1:** Ensure the restraint has been installed and set up as per “Set Up” and “Installation” (refer pages 11-21)

**Step 2:** To lengthen the harness “LIFT” the harness adjuster (refer Figure 2) whilst grasping both shoulder harness straps and pulling. Ensure shoulder straps are pulled equally on each side.



### WARNING

To ensure infant's back is evenly supported, do not put more than one nappy on the baby and make sure the nappy is not thickly folded at the back.

**Step 3:** Place child in car seat with legs either side of the buckle, place harness over the shoulders and hips (refer Figure 3) .

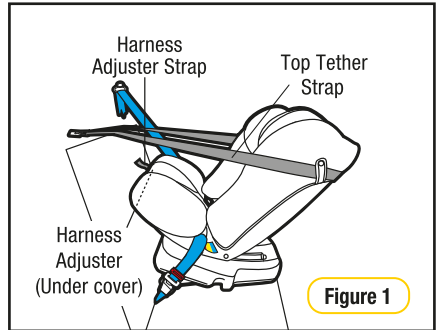
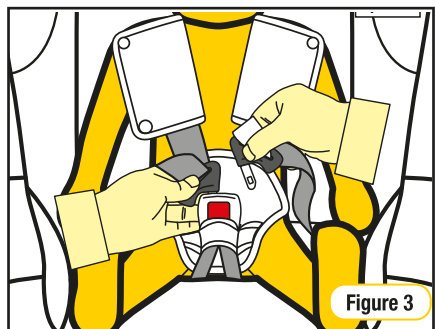
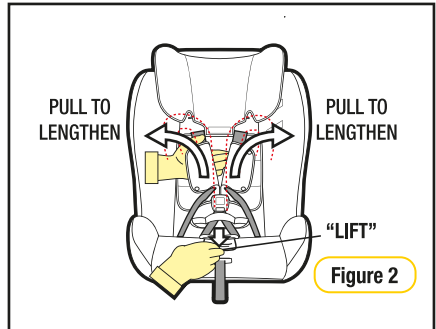

Figure 1



# Use

## Using Inbuilt Harness

**Step 4:** Insert either tongue into the buckle followed by the other tongue until a **“CLICK”** is heard. Should the second tongue not insert, press the red button and reinsert the tongues. Ensure secure engagement by pulling the harness strap (refer Figure 4).



### IMPORTANT

If no **“Click”** can be heard or a secure engagement cannot be achieved refer to Cleaning Buckle Harness page 57.

**Step 5:** Remove all of the slack for the harness lap straps by pulling shoulder straps (refer Figure 5), then pull the harness adjustment strap to adjust harness to a comfortable but firm fit (refer Figure 5 & 6).



### WARNINGS

- **DO NOT LEAVE CHILDREN UNATTENDED IN THE CAR.**
- Fit the harness firmly to the child.
- **A LOOSE RESTRAINT OR HARNESS IS DANGEROUS.**

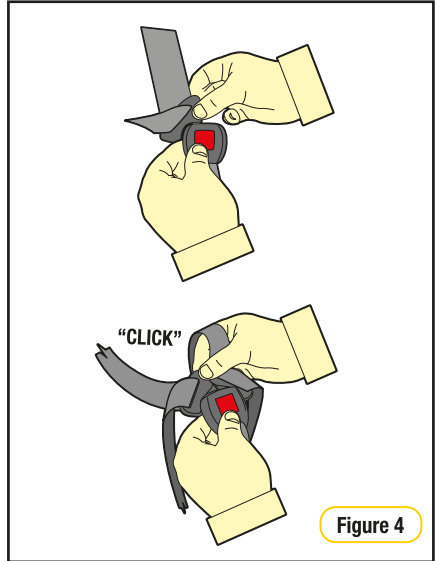

Figure 4

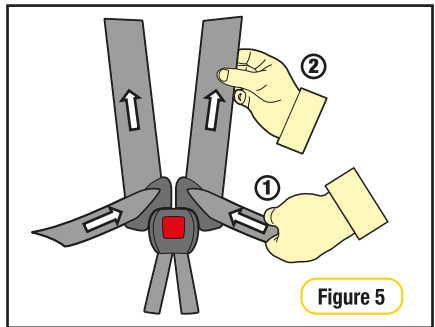

Figure 5



## Using Inbuilt Harness



### IMPORTANT

- **A LOOSE HARNESS IS DANGEROUS.**
- The Padded Insert/s (if fitted) are designed to provide extra support and comfort for small babies. Discontinue use when the insert is a tight fit or creates discomfort for larger babies/children.
- Always adjust the height of the shoulder straps as the child grows.

**Step 6:** Check the harness tightness by the **PINCH TEST**, this is achieved by pinching the harness webbing at the shoulders (refer Figure 7)

- If you can pinch the harness strap, tighten more.
- If your fingers slip off, then the harness is tight enough.

If required repeat Step 5.

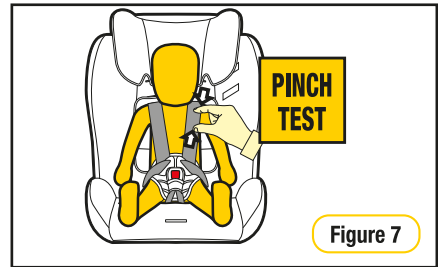
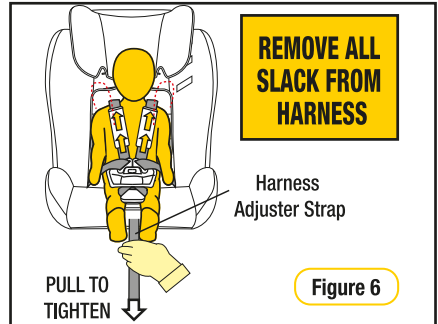

# Use

## To Release Infant

**Step 1:** To release your child from the restraint simply press the harness buckle and carefully remove your child from the restraint (refer Figure 1).

**NOTE:** If Top Tether strap has been loosened to allow easier placing of the baby in the restraint, always retighten the Top Tether strap so it has no slack in it. **DO NOT OVERTIGHTEN.**

### For Ease Of Use

No need to disconnect the Upper Anchorage Strap. To **access** your baby simply;

- Loosen upper tether strap (refer Figure 2).
- Lower strap out of way (refer Figure 3).

Reverse procedure when reseating the baby.



## WARNING

- Always use a lap or lap-sash seat belt and top tether strap to attach the child restraint to the vehicle.
- Do not use the restraint without the top tether strap correctly attached and adjusted.
- Do not use on any vehicle seat which faces sideways or rearwards.
- IF AN AIRBAG IS FITTED IN THE SEATING POSITION WHERE THE CHILD RESTRAINT IS TO BE FITTED, FOLLOW THE VEHICLE MANUFACTURER'S WARNINGS AND INSTRUCTIONS.
- Do not use the restraint if the buckle is sluggish or does not provide an audible "Click" refer to Cleaning Instructions on page 57.

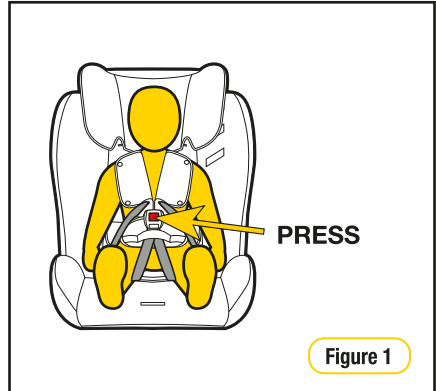

Figure 1

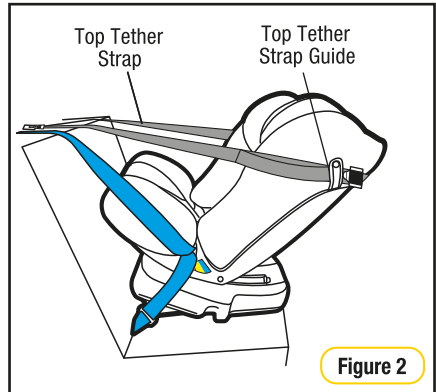

Figure 2

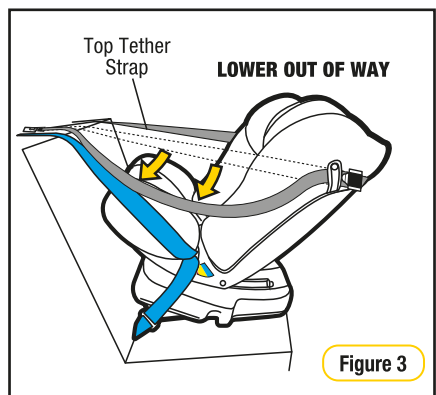

Figure 3

# Installation

## Forward Facing

### THE SUITABILITY OF THE CHILD RESTRAINT TO GROUPS OF CHILDREN

#### TYPE A2

To be used only in a rearward-facing position with built-in harness until the infant's shoulders reach the lower shoulder height marker (approximately 12 months of age).

#### TYPE B

Then to be used in a forward-facing position with built-in harness until the child's shoulders are above the middle shoulder height marker (approximately 4 years of age).

#### TYPE E

Finally, to be used with a lap-sash seatbelt until the child's shoulders reach the upper shoulder height marker (approximately 6 to 8 years of age).

Continue to use this child restraint until the child reaches this limit

Do not use forward-facing until child's shoulders are above the lower shoulder height marker.

Infants are at risk of serious injury if they face forward too early.

If the child's knees do not bend in front of the vehicle seat cushion, continue to use a booster seat.

Children are safest in the child restraint in the booster seat mode until their shoulders reach the upper shoulder height marker of the booster seat.

Just using a seatbelt is not recommended for children that have outgrown this seat. Use a larger booster seat.

**TO BE USED WITH A LAP-SASH/LAP-ONLY SEATBELT IN THE BACK OF MOST CARS WITH FORWARD FACING SEATS.**

The use of child restraints in the front seat may be restricted for children of specific ages by local legislation. Please check with your local Department of Transport for the specific seating locations of children using child restraints for their given ages.



## IMPORTANT

- For a vehicle without a fixed parcel shelf an extension strap(s) may be needed (Refer page 63). If so ring (02) 4728 8090 for nearest supply location.
- Seatbelt extenders are not recommended to be used if the seatbelt is not long enough to secure the child restraint. If seatbelts are too short then advice should be sought from a child restraint fitter and their recommendation be considered before using a seatbelt extender.

# Shoulder Height Marker

## Smaller Toddler (using inbuilt harness)

Shoulder height markers are provided on this restraint for a visual indication that the child is safe to travel in this restraint.

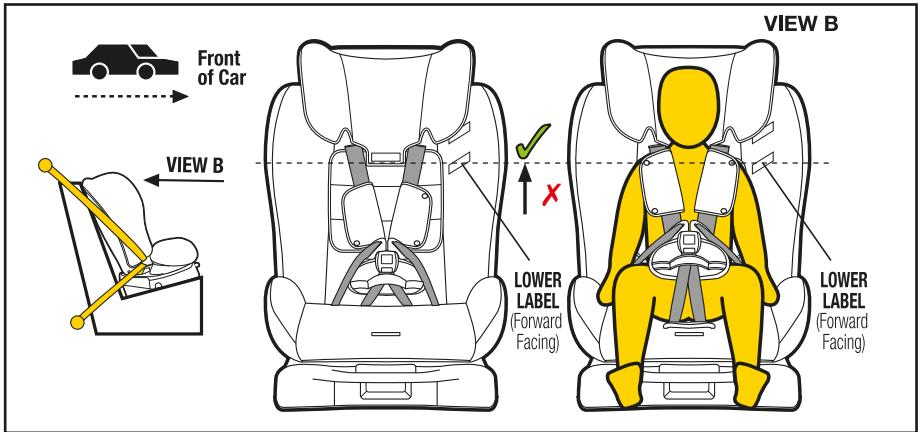

## Smaller Child from approximately 12 months of age

Do not use as a forward-facing child restraint until the child's shoulders are **ABOVE** the Lower shoulder height marker (Lower label).

LOWER LABEL

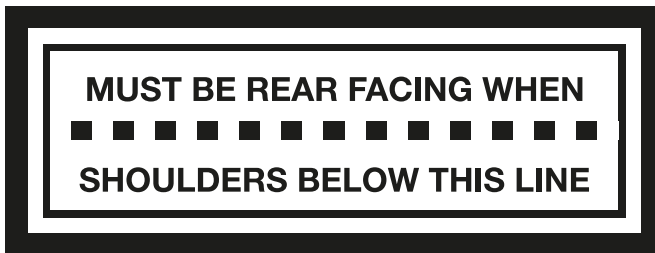

## **IMPORTANT**

When using the inbuilt harness the child's shoulders must be in-line or **above** this marker

If moving a child from rearward-facing child restraint, to forward facing child restraint the child's shoulders will need to be inline or above the lower label. If the child's shoulders are below the lower label or if the baby's neck muscles are unable to support their head, then the child should remain rearward-facing.

# Shoulder Height Marker

## Taller Toddler (using inbuilt harness)

Shoulder height markers are provided on this restraint for a visual indication that the child is safe to travel in this restraint.

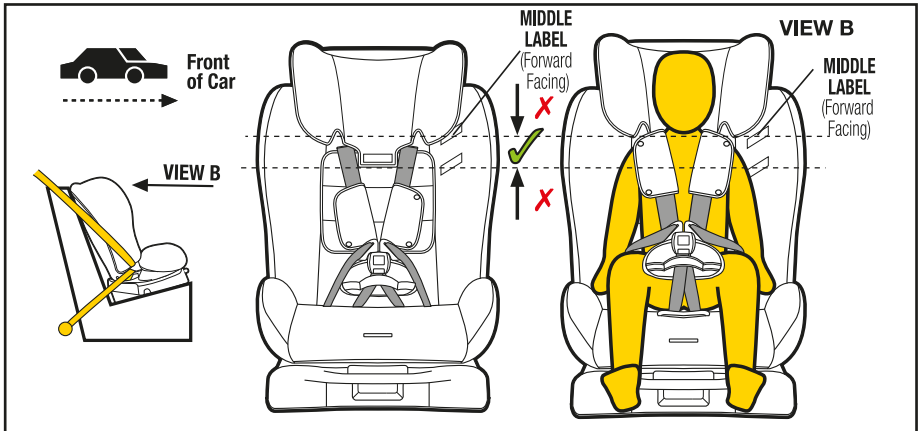

### Taller Child to approximately 4 years of age

Continue to use as a forward-facing child restraint until the child's shoulders **REACH** the middle shoulder height marker (Middle label).

MIDDLE LABEL (Forward-Facing)



## **IMPORTANT**

When the child's shoulders reach the shoulder height marker (Middle Label), convert the child restraint to booster seat mode and use with a lap sash seat belt.

Children are at risk of serious injury if they move to booster seats too early.

Children that have outgrown the forward-facing child restraint are safest in a booster seat until their shoulders reach the upper shoulder height marker of the booster seat.

# Model CS4313

## Forward Facing

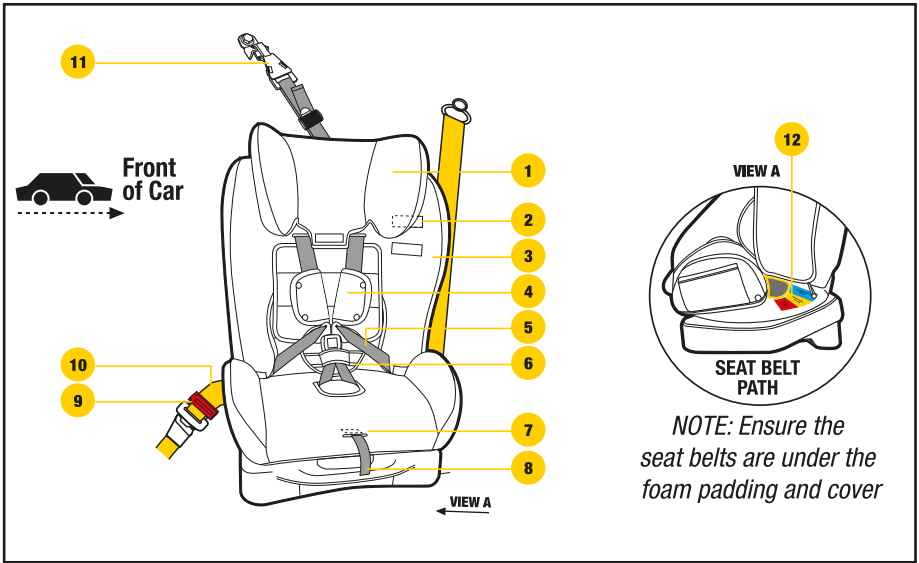

1. Headrest
2. Shoulder Height Markers
3. Comfort Cover
4. Shoulder Pads
5. Harness Straps
6. Buckle Pad
7. Harness Adjuster
8. Harness Adjustment Strap
9. Safe Grip Red Belt Clamp (if supplied with restraint)
10. Vehicle Seat Belt

11. Top Tether Assembly
  - Tether Strap
  - Adjuster
  - Attachment Clip
  - Anchor Fitting + Attachment Hardware
12. "FORWARD-FACING SEAT BELT PATH" Marker (each side of restraint - coloured Yellow)

NOTE: Padded inserts can vary according to model. For detailed description and method of attachment for padded accessories refer to Accessories on page 59.

# Set Up

## Selection of appropriate padding combinations

**Step 1:** Determine whether your child requires the additional padding provided with this restraint, to ensure a safe and snug fit in the restraint. Refer to page 6 for suggested padding combinations.

## Converting To Child Seat

### Reclined Position

**Step 1:** Ensure the recline section is swung rearward (see Figure 1 & 2).

**Step 2:** At the front of the restraint is a red lever. Pull red lever forward and slide the seat to obtain the desired upright or reclined angle.

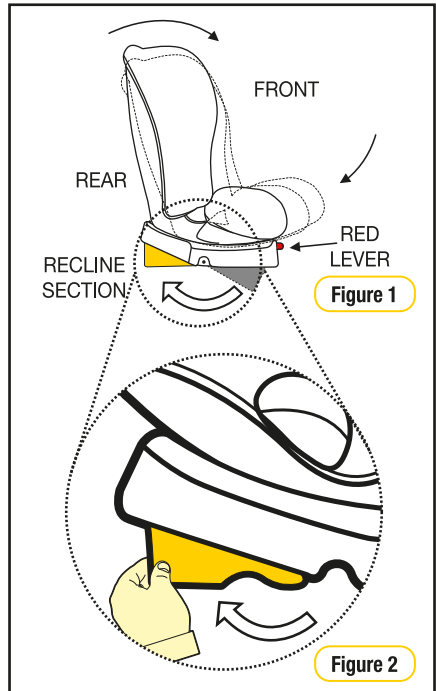

### Adjuster Assembly Location

#### Forward Facing (Type B)

**Step 1:** Pull excess strap through the top section (1) whilst feeding the adjuster section (2) towards the seat (See Figure 3).

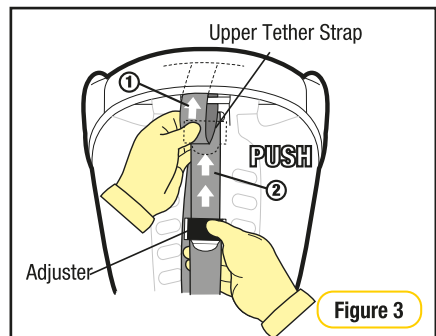

# Set Up

## Adjuster Assembly Location (continued)

### Forward Facing (Type B)

**Step 2:** Continue to shorten until you have reached the desired position at the rear of the restraint (See Figure 4).

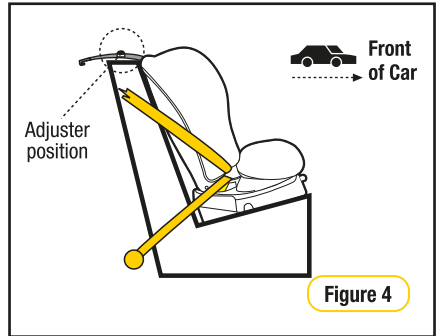

## Shoulder Height

The correct height for the shoulder straps is very important for the optimum performance of the restraint. The shoulder strap slots used in forward facing position are the upper and middle positions.



### IMPORTANT

The shoulder straps must be in the slots which are nearest to the child's shoulders, but more than 25mm below the child's shoulders.

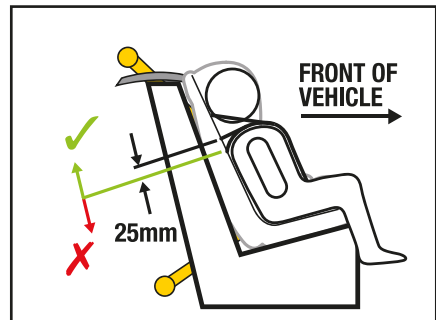

## Adjusting the Headrest

The headrest can be adjusted to different heights to best suit your child. The headrest has a locking nut on the rear of the restraint. This can be done with the child in the seat.

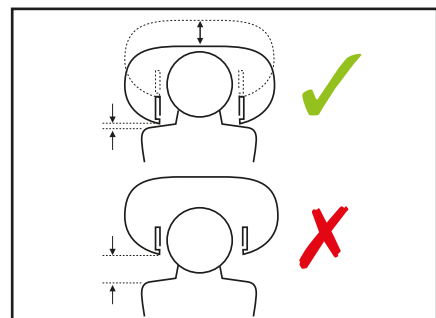



# Set Up

## Adjusting the Headrest cont...

**Step 1:** Undo the adjustment nut which is located at the back of the restraint, to move the headrest either up or down (refer Figure 1).

**Step 2:** Adjust the headrest height so that the bottom of the headrest is located level with or just above the child's shoulder (refer Figure 2).

**Step 3:** Once the headrest is in the correct position tighten the adjustment nut and check the headrest is locked into place.

**Step 4:** Check to sight the location of the appropriate shoulder slots (in main shell), refer Figure 3.

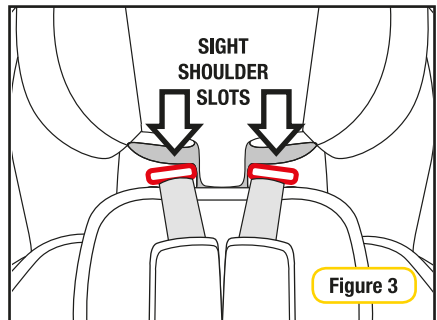
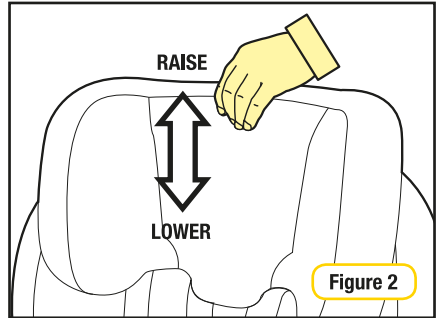
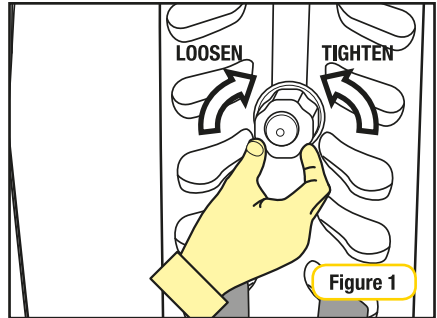

# Set Up

## Shoulder Height Slot Section

**Step 1:** Loosen harness to allow spreader plate to rise from under the restraint. Turn the restraint so that the back of the seat is facing you.

**Step 2:** Remove each shoulder harness through the gates in the spreader plate (see Figure 1 & 4).

**Step 3:** Pull the shoulder harness straps through the shoulder slot holes in the seat body and cover. They are now loose in the front of the seat.

**Step 4:** Push the ends of the shoulder harness straps through the appropriate shoulder slot holes in the cover and seat body for the child's shoulder height.

**NOTE:** Ensure the harness straps are not twisted.

**Step 5:** The shoulder harness straps go directly from the shoulder slot holes to the spreader plate. Thread each shoulder harness strap back onto the metal spreader plate through the gate (see Figure 4).

### **IMPORTANT**

- The shoulder straps must be in the slots which are nearest to the child's shoulders, but not lower than the child's shoulders.
- Always adjust the height of the shoulder straps as the child grows.

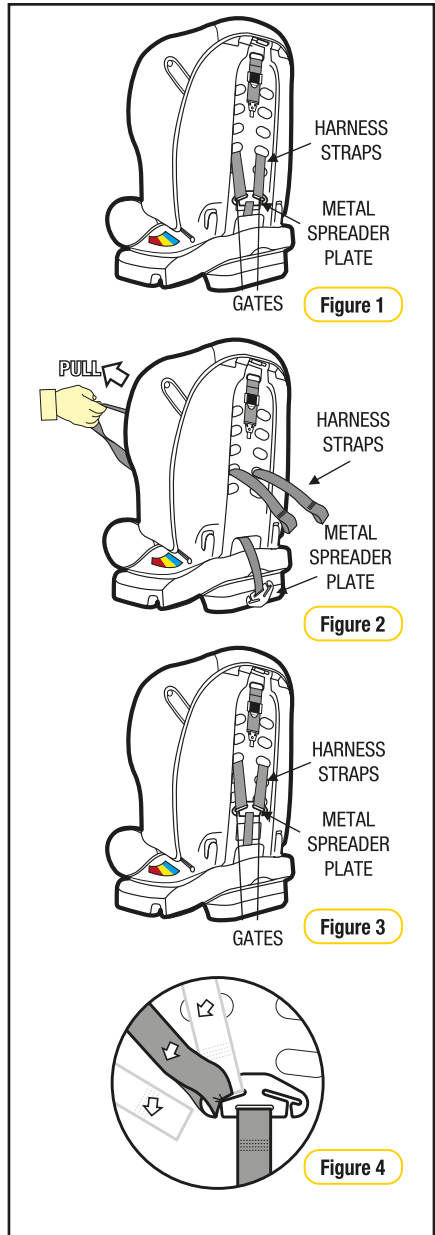

# Installation

## Installing Using Vehicle Seatbelt

**Step 1:** Place the restraint in desired upright or reclined position, with the back against the back of the vehicle seat, directly in line with the anchorage point (refer Figure 1).



### IMPORTANT

Ensure that you use the **FORWARD-FACING BELT PATH** indicators, marked in “yellow”

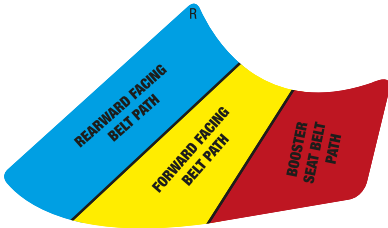

**Step 2:** Feed adult lap or lap/sash belts through the belt path opening, ensure the seat belt is under the cover & between the layer of foam and the plastic seat base. (refer Figure 2 & 3)

Engage the buckle and tongue assembly (listen for a “CLICK”). Check the buckle engagement with a gentle pull.

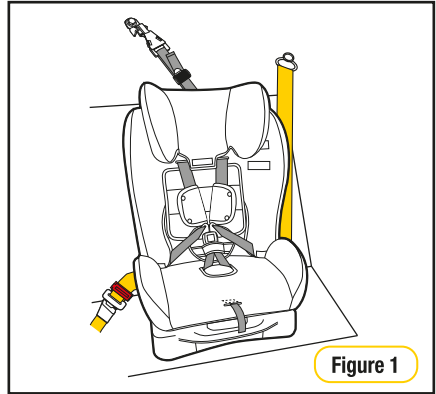

Figure 1

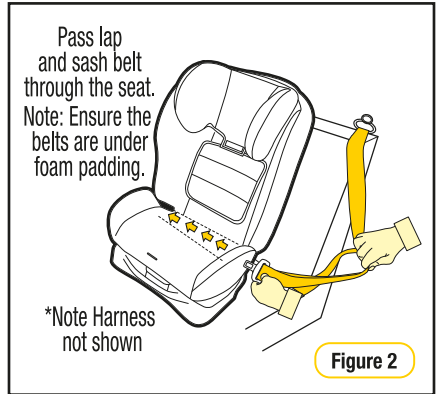

Figure 2

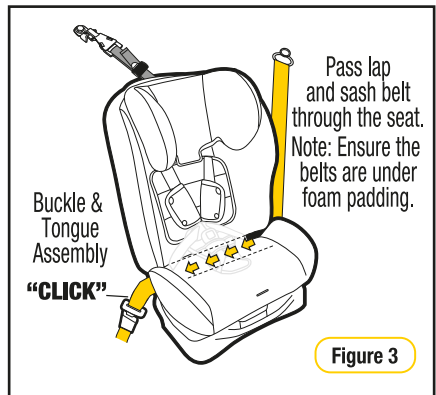

Figure 3

# Installation

## Installing Using Vehicle Seatbelt



### WARNING

- Always use upper anchorage strap to attach the child restraint to the vehicle.
- Do not use the restraint without the upper anchorage strap correctly attached and adjusted.
- Do not use on any vehicle seat which faces sideways or rearwards.
- IF AN AIRBAG IS FITTED IN THE SEATING POSITION WHERE THE CHILD RESTRAINT IS TO BE FITTED, FOLLOW THE VEHICLE MANUFACTURER'S WARNINGS AND INSTRUCTIONS.
- Fit the restraint firmly to the car seat.

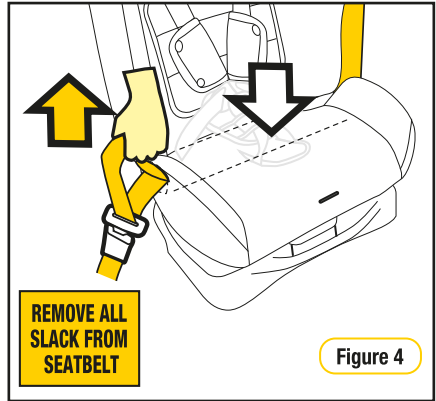

**Step 3:** Push down on the base of the restraint (with knee or hand) whilst pulling the sash section of the vehicle belt firmly up in the direction of the yellow arrow in Figure 4. (This will tighten the lap belt across the seat base). Whilst continuing to pull the sash section up, attach the Safe Grip red belt clamp on the sash section ONLY as close as possible above the buckle tongue assembly. (Refer to Figure 5 and Instruction for installing the Safe Grip red clamp below)

**Step 4:** Ensure the excess slack in the sash belt, is fed back towards the seat belt

# Installation

## Installing Using Vehicle Seatbelt

### Safe Grip (if supplied)

\* The Safe Grip may not be supplied with all models. It can be purchased separately; visit <http://store.infasecure.com.au>

### SAFE GRIP BELT CLAMP

The Safe Grip (red belt clamp) **locks the lap belt** to ensure a firm installation, and avoids slack in the lap belt.

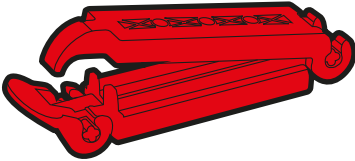

To install the **Safe Grip** (red belt clamp), open it and clamp the “sash section” **ONLY** of the vehicle seat belt by closing the barrel section of the red belt clamp in the direction of arrow 1 in Figure 5 and then locking with the toggle section by pushing in the direction of arrow 2 in Figure 5 when the **Safe Grip** (red belt clamp) is secured in place, the lap section is now tightly holding your child restraint in place, independent of the sash section. The **Safe Grip** (red belt clamp) must be removed when the child restraint is not installed to allow other users to use the seat belt as a lap/sash seat belt. Always keep the **Safe Grip** (red belt clamp) in pocket provided when not in use.

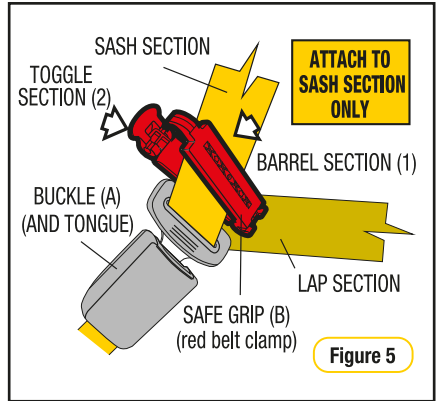

Figure 5

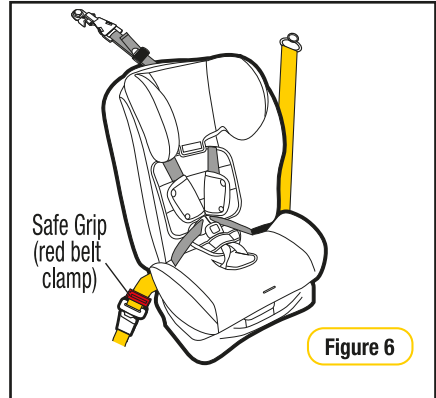

Figure 6

# Installation

## Installing Using Vehicle Seatbelt

**Note:** If no upper anchorage fitting is available refer to Pages 63-65.

**Step 5:** Hook the attachment clip to the anchor fitting. Ensure there are no twists in the top tether strap (Refer to Figure 7)

**Step 6:** Pull to tighten to remove all the slack, from the upper anchorage strap. Do not overtighten as this could cause the restraint to lift off the vehicle seat (Refer to Figure 8).

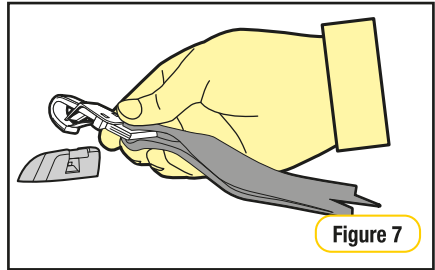

### NOTE

**FOLLOWING THE INSTALLATION OF THE CHILD RESTRAINT A SMALL AMOUNT OF MOVEMENT IS DEEMED ACCEPTABLE.**

**CAUTION: CHILDREN CAN BE INJURED OR RESTRAINTS AND TOP TETHER STRAP DAMAGED BY UNSECURED CARGO IN A COLLISION. SECURE OR REMOVE HAZARDOUS CARGO BEFORE USING THIS CHILD RESTRAINT.**

Always secure the loose end of the top tether strap to prevent it hanging out of the car or being accessible by the child.

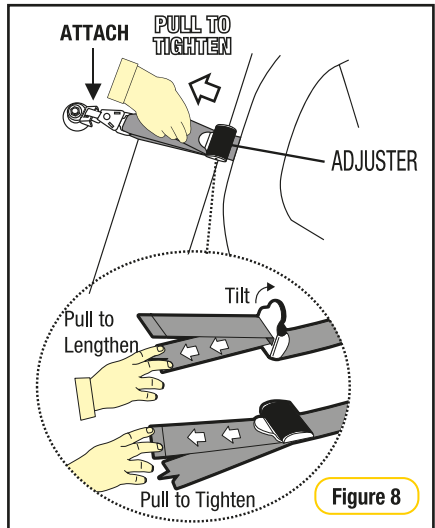

## Tether Storage

After correctly installing the restraint in your car, roll up and place any excess tether strap in the storage pocket provided (refer Figure 9)

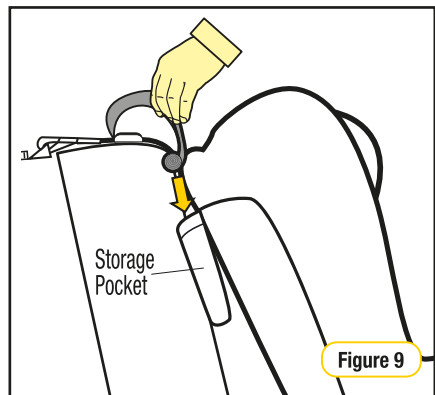

# Use

## Adjusting Recline Angle

**NOTE:** To adjust the recline angle of the child seat, refer to “Converting to Child Seat” on page 30.

**Step 1:** First loosen the seatbelt assembly, the Safe Grip Belt Clamp may need to be removed.

**Step 2:** At the front of the restraint is a red lever. Pull red lever forward and slide the seat to obtain the desired upright or reclined angle (refer Figure 1)

**Step 3:** Reinstall the seatbelt and Safe Grip Belt Clamp (refer pages 34-36).

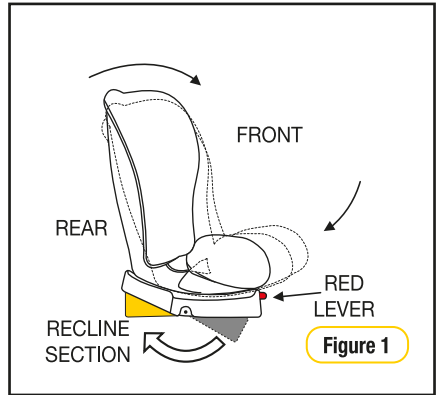

## Using Inbuilt Harness

**Step 1:** Ensure the restraint has been installed and set up as per “Set Up” and “Installation” (refer page 30-36)

**Step 2:** To lengthen the harness “LIFT” the harness adjuster (refer Figure 1) whilst grasping both shoulder harness straps and pulling. Ensure shoulder straps are pulled equally on each side.

**Step 3:** Place child in car seat with legs either side of the buckle, place harness over the shoulders and hips (refer Figure 2) .

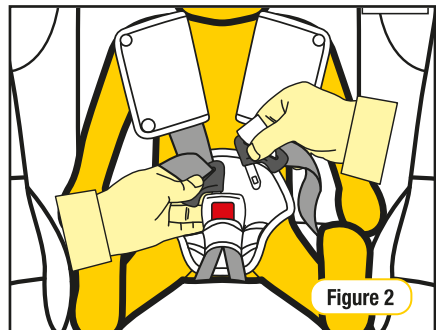
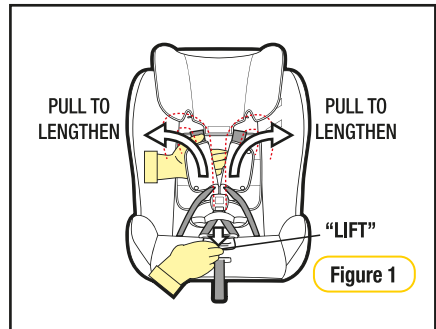

# Installation

## Using Inbuilt Harness

**Step 4:** Insert either tongue into the buckle followed by the other tongue until a “CLICK” is heard. Should the second tongue not insert, press the red button and reinsert the tongues. Ensure secure engagement by pulling the harness strap (refer Figure 3).

### **IMPORTANT**

If no “Click” can be heard or a secure engagement cannot be achieved refer to Cleaning Buckle Harness page 57.

**Step 5:** Remove all of the slack from the harness lap straps by pulling shoulder straps (refer Figure 4), then pull the harness adjustment strap to adjust harness to a comfortable but firm fit (refer Figure 4 & 5).

### **WARNINGS**

- **DO NOT LEAVE CHILDREN UNATTENDED IN THE CAR.**
- Fit the harness firmly to the child.
- **A LOOSE RESTRAINT OR HARNESS IS DANGEROUS.**

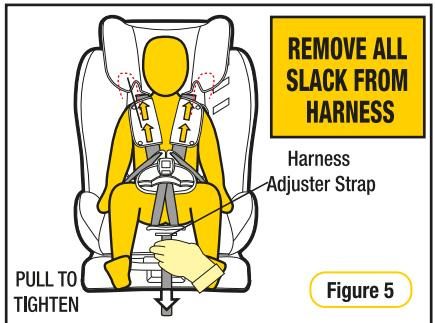
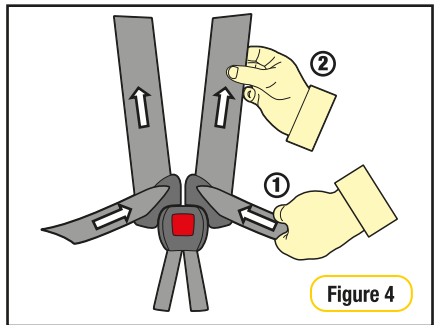
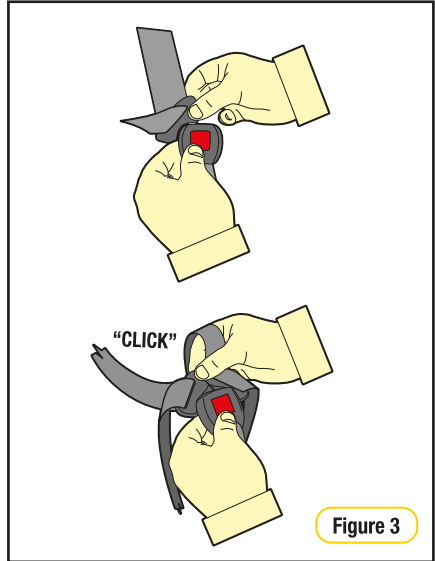



# Use

## Using Inbuilt Harness

### **IMPORTANT**

- **A LOOSE HARNESS IS DANGEROUS.**
- The Padded Insert/s (if fitted) are designed to provide extra support and comfort for small babies. Discontinue use when the insert is a tight fit or creates discomfort for larger babies/children.
- Always adjust the height of the shoulder straps as the child grows.

**Step 6:** Check the harness tightness by the **PINCH TEST**, this is achieved by pinching the harness webbing at the shoulders (refer Figure 6)

- If you can pinch the harness strap, tighten more.
- If your fingers slip off, then the harness is tight enough.

If required repeat Step 5.

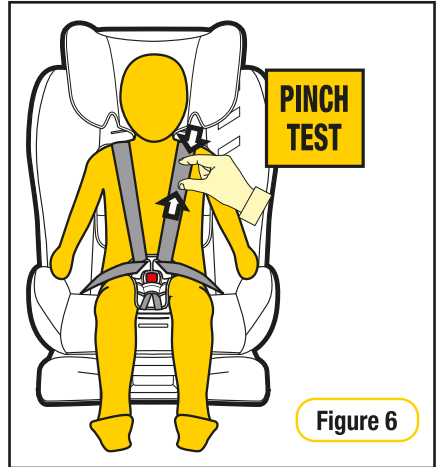

## To Release Child

**Step 1:** To release your child from the restraint simply press the harness buckle and carefully remove your child from the restraint (refer Figure 1).

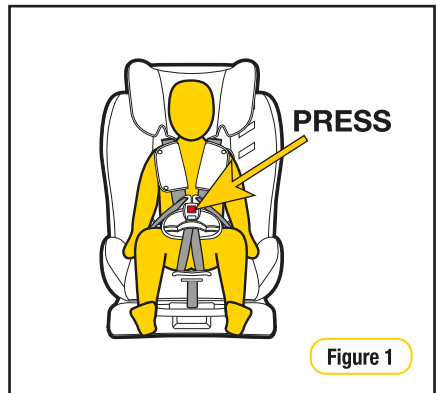

# Booster Seat

## Forward Facing

### THE SUITABILITY OF THE CHILD RESTRAINT TO GROUPS OF CHILDREN

#### TYPE A2

To be used only in a rearward-facing position with built-in harness until the infant's shoulders reach the lower shoulder height marker (approximately 12 months of age).

#### TYPE B

Then to be used in a forward-facing position with built-in harness until the child's shoulders are above the middle shoulder height marker (approximately 4 years of age).

#### TYPE E

Finally, to be used with a lap-sash seatbelt until the child's shoulders reach the upper shoulder height marker (approximately 6 to 8 years of age).

Continue to use this child restraint until the child reaches this limit

Do not use forward-facing until child's shoulders are above the lower shoulder height marker.

Infants are at risk of serious injury if they face forward too early.

If the child's knees do not bend in front of the vehicle seat cushion, continue to use a booster seat.

Children are safest in the child restraint in the booster seat mode until their shoulders reach the upper shoulder height marker of the booster seat.

Just using a seatbelt is not recommended for children that have outgrown this seat. Use a larger booster seat.

**THIS RESTRAINT MUST BE USED IN CARS WITH FORWARD-FACING SEATS WITH A LAP-SASH SEATBELT. THIS BOOSTER SEAT IS NOT SUITABLE FOR USE WITH A CHILD HARNESS.**

The use of child restraints in the front seat may be restricted for children of specific ages by local legislation. Please check with your local Department of Transport for the specific seating locations of children using child restraints for their given ages.



- DO NOT USE WITH JUST A LAP BELT. You must use with a lap-sash seatbelt.
- The lap part of the seatbelt must be firmly across the thighs and the sash belt fitted diagonally across the chest and on the shoulder.

# Model CS4313

## Forward Facing

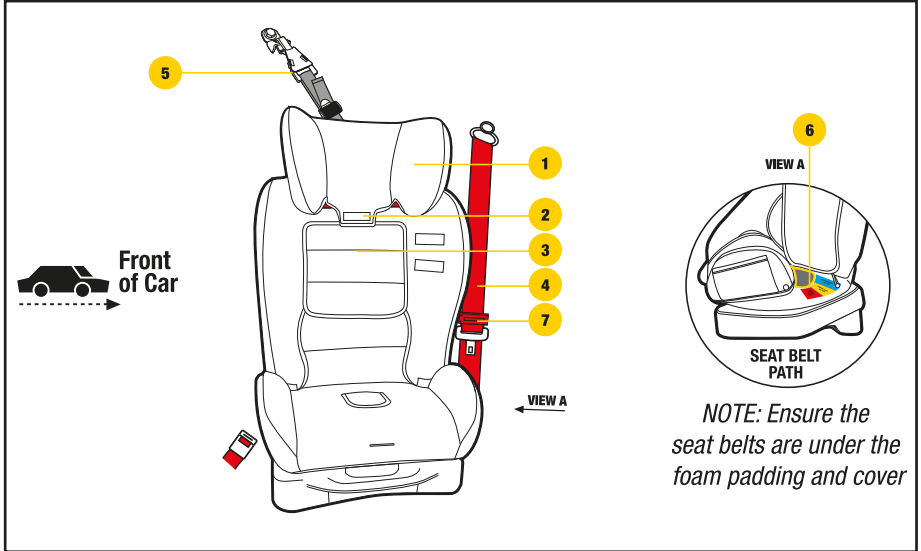

1. Headrest
2. Shoulder Height Markers
3. Comfort Cover
4. Vehicle Seatbelt
5. Top Tether Assembly
  - Tether Strap
  - Adjuster
  - Attachment Clip
  - Anchor Fitting + Attachment Hardware
6. "Booster Seat Belt Path" Marker (Each side of restraint - Coloured Red)
7. Safe Grip Red Belt Clamp (if supplied with restraint)

## IMPORTANT

- For a vehicle without a fixed parcel shelf an extension strap(s) may be needed (refer page 63). If so ring (02) 4728 8090 for nearest supply location.
- Seatbelt extenders are not recommended to be used if the seatbelt is not long enough to secure the child restraint. If seatbelts are too short then advice should be sought from a child restraint fitter and their recommendation be considered before using a seatbelt extender.

# Shoulder Height Marker

## Smaller Child (using lap-sash seatbelt)

Shoulder height markers are provided on this restraint for a visual indication that the child is safe to travel in this restraint.

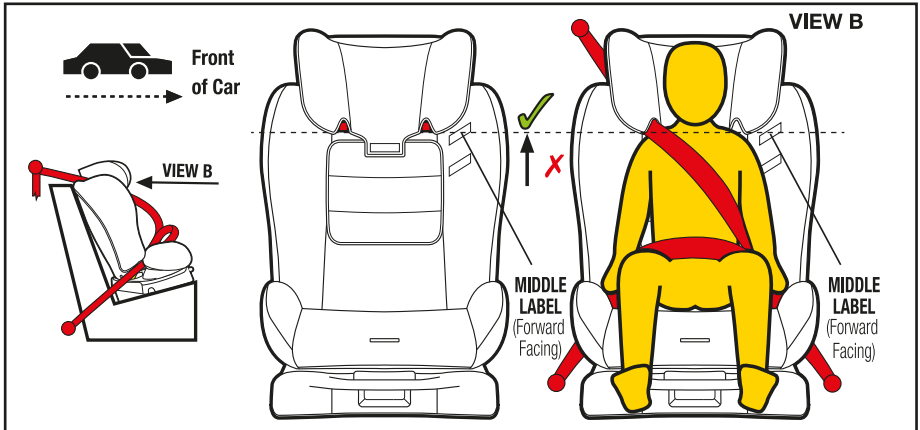

## Smaller Child from approximately 4 years of age

Do not use as a booster seat until the child's shoulders are **ABOVE** the middle shoulder height marker (Middle label).

MIDDLE LABEL (Forward-Facing)



## IMPORTANT

When the child's shoulders reach the shoulder height marker (Middle Label), convert the child restraint to booster seat mode and use with a lap sash seat belt.

If moving a child from forward-facing child restraint, to a booster seat the child's shoulders will need to be in-line or above the middle label. If the child's shoulders are below the middle label, then the child should remain forward-facing using internal harness.

# Shoulder Height Marker

## Taller Child (using lap-sash seatbelt)

Do not continue to use the restraint if the child's shoulder are above the Upper Label.

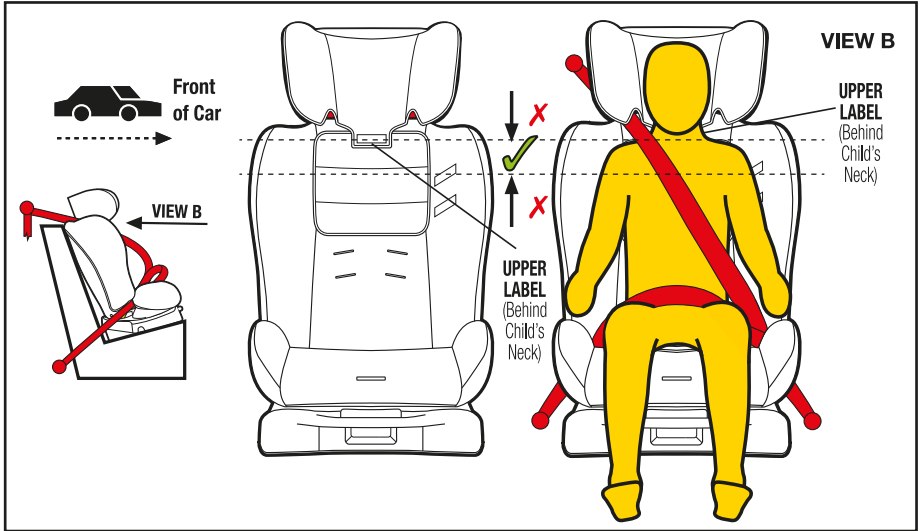

### Taller Child from approximately 8 years of age

Continue to use as a booster seat until the child's shoulders are **REACH** the upper shoulder height marker (Upper label).

UPPER LABEL (Forward-Facing)



Children are at risk of serious injury if they move to booster seats too early.

Children that have outgrown the forward-facing child restraint are safest in a booster seat until their shoulders reach the upper shoulder height marker of the booster seat.

The child restraint is unsuitable for the occupant when the shoulders are above the upper marker. The child needs to be moved into the next form of child restraint eg. Larger Type E booster seat or Type F booster seat when they reach the top shoulder height marker.

For the next child restraint refer to the Restraint Guide on page 5 & 45.

# Next Restraint

## Next Type of Restraint

Refer to the 'RESTRAINT GUIDE' for the selection for the most appropriate next restraint (refer Page 5). When the child has outgrown the booster seat, then you can use either of the following;

- **Large Booster Seat** – Larger type E or Type F Booster seat.
- **Vehicle Seat Belt** – check the “Five Step Test” for suitability.

## Five Step Test

**Step 1:** Can the child sit with their back against the vehicle seat back? (refer Figure 1).

**Step 2:** Do the child's knees bend in front of the edge of the seat? (refer Figure 2).

**Step 3:** Does the sash (shoulder) belt sit across the middle of the shoulder, not on the neck or out near the arm? (refer Figure 3).

**Step 4:** Is the lap belt sitting low across the hips touching the thighs? (refer Figure 4).

**Step 5:** Can the child stay seated like this for the whole trip? (refer Figure 5).

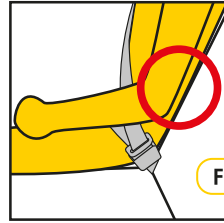

Figure 1

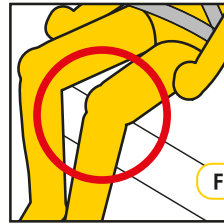

Figure 2



Figure 3

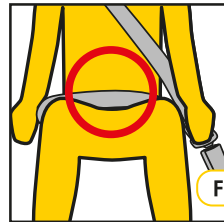

Figure 4

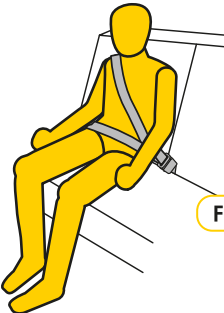

Figure 5

# Set Up

## Selection of appropriate padding combinations

Determine whether your child requires the additional padding provided with this restraint, to ensure a safe and snug fit in the restraint. Refer to page 6 for suggested padding combinations.

## Converting to a child booster

### **IMPORTANT**

FOR USE OF THIS RESTRAINT AS A BOOSTER SEAT THE HARNESS MUST BE STORED BEHIND THE COVER. THE FOLLOWING STEPS EXPLAIN HOW THIS IS TO BE DONE.

**Step 1:** Disengage the buckle, undo the cover flap located between the leg straps and place the buckle in the recessed section of the plastic base. Close the flap in the cover (Refer to Figure 1 & 2).

**Step 2:** Disengage shoulder straps from spreader plate as shown on page 17 & 33. (To change the shoulder slot height, steps 1 to 5). Remove shoulder pads & buckle pads and store in a safe place for keeping. Place the shoulder straps behind the cover, thread through the backrest shoulder slots and reconnect to the metal spreader plate. Tightening the harness with harness adjuster strap located at the front of the seat. Place the two buckle tongues in the recess in the plastic base at point (A) in Figure 3.

The harness is now behind the seat cover for storage until needed as a car seat.

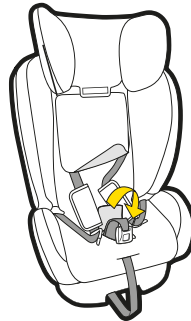

Figure 1

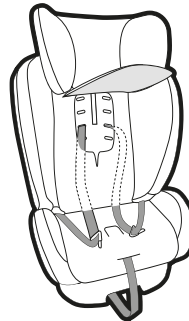

Figure 2

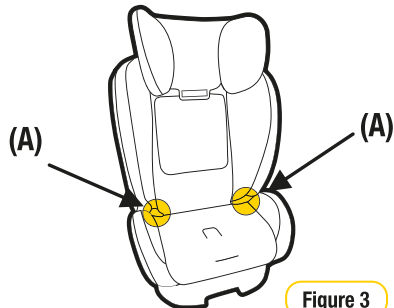
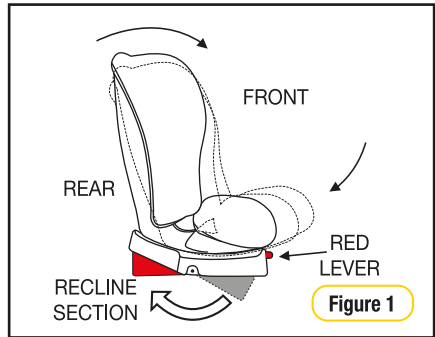

Figure 3

# Set Up

## Reclined Position

Ensure the recline section is swung rearward (see Figure 1). At the front of the restraint is a red lever. Pull red lever forward and slide the seat to obtain the desired upright or reclined angle.



## Converting to a booster seat

### Adjuster Assembly Location

#### Forward Facing (Type B)

**Step 1:** Pull excess strap through the top section (1) whilst feeding the adjuster section (2) towards the seat (see Figure 2).

**Step 2:** Continue to shorten until you have reached the desired position at the rear of the restraint (see Figure 3).

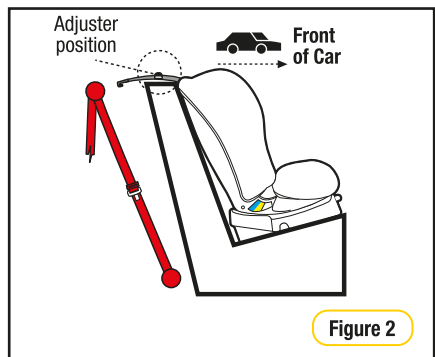
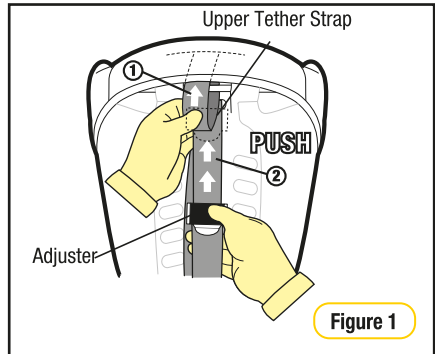



# Set Up

## Adjusting the Headrest

The headrest can be adjusted to different heights to best suit your child. The headrest has a locking nut on the rear of the restraint.

**Step 1:** Undo the adjustment nut which is located at the back of the restraint, to move the headrest either up or down (refer Figure 1).

**Step 2:** Adjust the headrest height so that the bottom of the headrest is located level with or just above the child's shoulder (refer Figure 2).

**Step 3:** Once the headrest is in the correct position tighten the adjustment nut and check the headrest is locked into place.

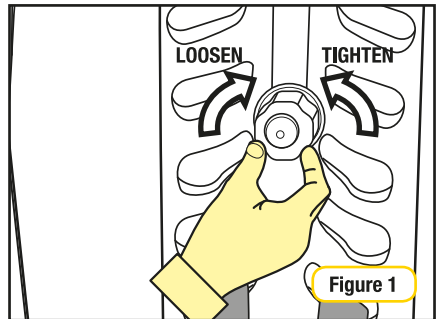
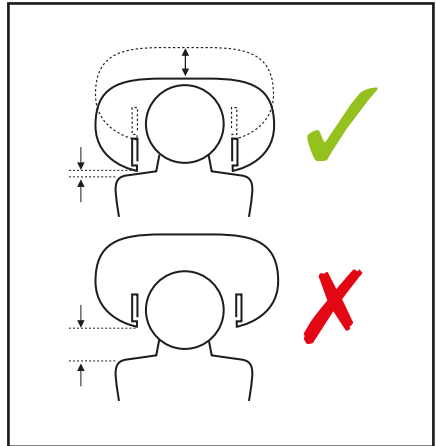

Figure 1

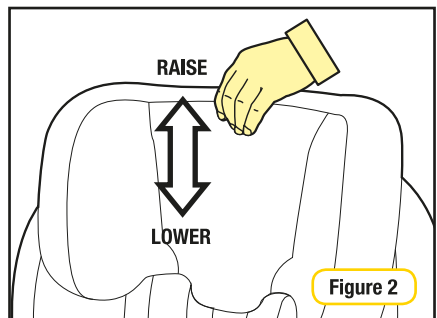

Figure 2

# Installation

## Installing in Vehicle

**Step 1:** Ensure the restraint is set up in booster seat mode (refer pages 46-48).

**Step 2:** Place the restraint in desired upright or reclined position, with the back against the back of the vehicle seat, directly in line with the anchorage point (refer Figure 1).

**Step 3:** If required, install the upper anchorage fitting as shown on page 64-65 of these instructions

**Step 4:** Hook the attachment clip to the anchor fitting. Ensure there are no twists in the top tether strap (Refer to figure 2)

**Step 5:** Pull to tighten and remove all the slack, from the top tether strap (refer to Figure 3). Do not overtighten as this could cause the restraint to lift off the vehicle seat.

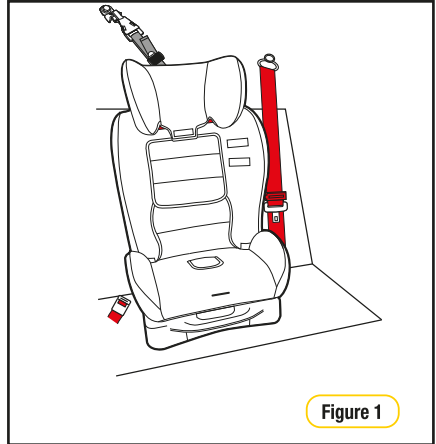

Figure 1

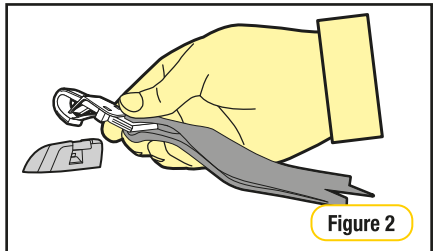

Figure 2

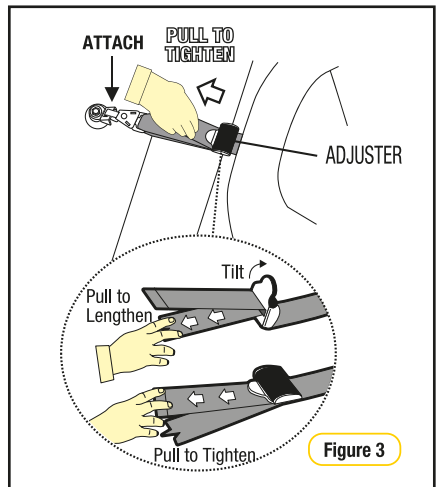

Figure 3

# Installation

## Installing in Vehicle

**CAUTION: CHILDREN CAN BE INJURED OR RESTRAINTS AND TOP TETHER STRAP DAMAGED BY UNSECURED CARGO IN A COLLISION. SECURE OR REMOVE HAZARDOUS CARGO BEFORE USING THIS CHILD RESTRAINT.**

Always secure the loose end of the top tether strap to prevent it hanging out of the car or being accessible by the child.



### IMPORTANT

- Tighten till slack is removed.
- In certain vehicles an extension strap may be needed.
- Do not overtighten Top Tether strap.
- Always secure the loose end of the top tether strap to prevent it hanging out of the car or being accessible by the child.

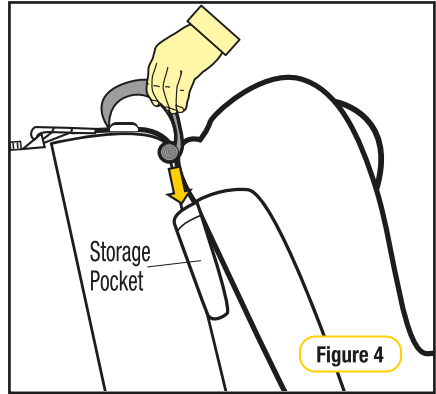

## Tether Storage

After correctly installing the restraint in your car, roll up and place any excess tether strap in the storage pocket provided (refer Figure 4)

# Use

## Using lap-sash seat belt

**Step 1:** Ensure the restraint has been installed as per “INSTALLING IN VEHICLE” (refer Figure 1, page 49 & 50).

**Step 2:** Sit your child in the restraint with their back against the backrest (refer Figure 2).



### IMPORTANT

Ensure that you use the **BOOSTER SEAT BELT PATH** indicators, marked in “red”.



Sashbelt

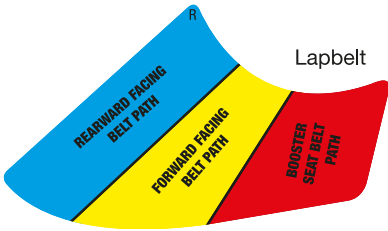

Lapbelt

**Step 3:** Position the lap section of the vehicle seatbelt across the child’s lap then insert the buckle tongue in to the belt buckle until you hear “CLICK”. Ensuring the lap portion is positioned through the booster seatbelt path and over the child’s thighs (refer Figure 3).



### WARNING

- DO NOT USE WITH JUST A LAP BELT. You must use a lap-sash seat belt.

**Step 4:** Pull the lap belt tight by first pulling on the lap belt in the direction of arrow 1 (refer Figure 3). Pull the sash belt tight in the direction of arrow 2.

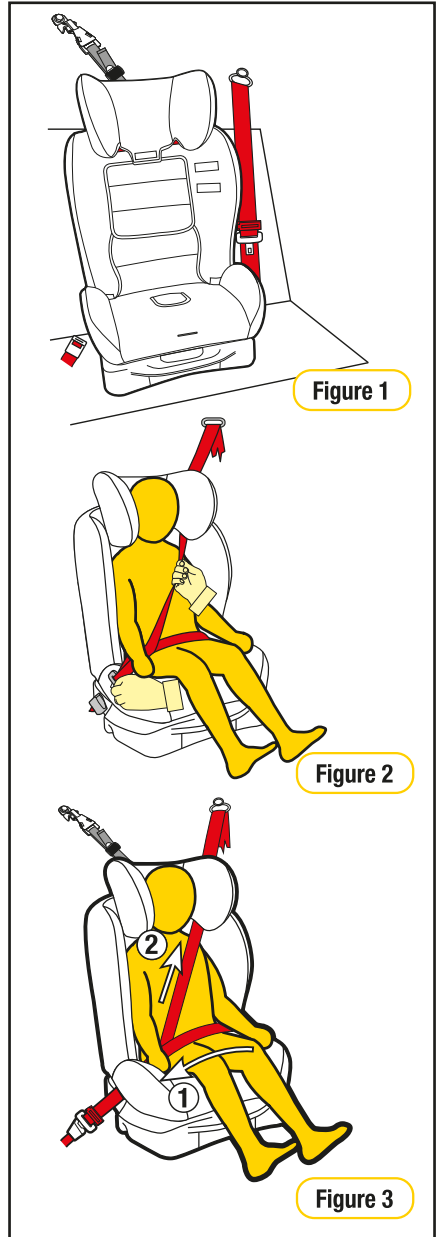

Figure 1

Figure 2

Figure 3

# Use

## Safe Grip (if supplied)

\* The Safe Grip may not be supplied with all models. It can be purchased separately; visit <http://store.infasecure.com.au>

### SAFE GRIP BELT CLAMP

It is important that the lap belt must be **firmly across the thighs**. The **Safe Grip locks the lap belt** to ensure a firm fit across the thighs, and avoids slack in the lap belt. This fit ensures that the lap belt **does not ride up** into the soft abdominal region of the child, which may cause internal injury.

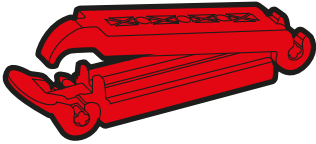

To install the **Safe Grip** (red belt clamp); Continue from **Step 6**: while holding the belts tight open the Safe Grip and clamp the “sash section” of the vehicle seat belt by closing the barrel section of the red belt clamp in the direction of arrow 3 (refer Figure 5) and then locking with the toggle section by pushing in the direction of arrow 4 (refer Figure 5) Note: Positioned as close as possible to the buckle and tongue. When the **Safe Grip** (red belt clamp) is secured in place, the lap section is now tightly holding your child in place, independent of the sash section. The **Safe Grip** (red belt clamp) can be left located on the sash belt when the child is removed from the booster. It is then ready for the next use. Repositioning of the **Safe Grip** (red belt clamp) may be required as the child grows. The **Safe Grip** (red belt clamp) must be removed when the child restraint is not installed to allow other users to use the seat belt as a lap/sash seat belt. Always keep the **Safe Grip** (red belt clamp) in pocket provided when not in use.

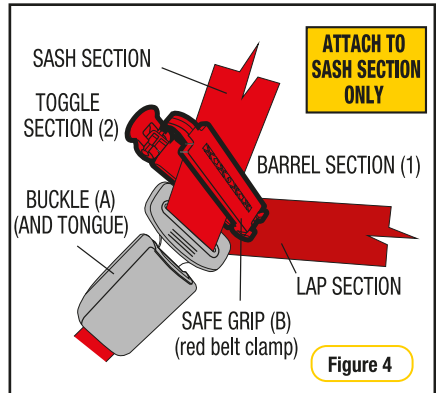

# Use

## Sash Guide (if supplied)

**Step 5:** Pass the shoulder belt through the belt sash guide built into the headrest (refer Figure 6).



### WARNING

- DO NOT LEAVE CHILDREN UNATTENDED IN THE CAR
- Fit the seat belt firmly to the child.

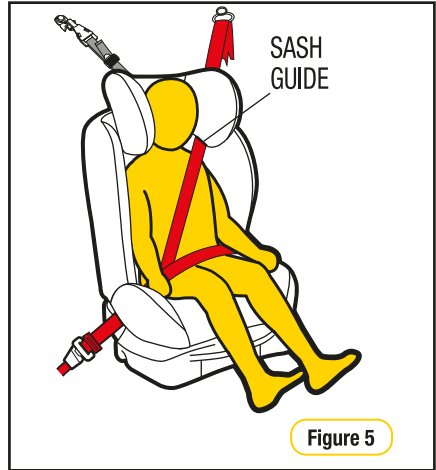

Figure 5



### WARNING

- ALWAYS USE THE SASH GUIDE

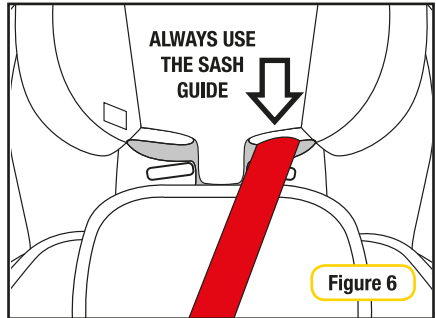

Figure 6

## Safety Warning



### WARNING

A SASH BELT UNDER THE ARM OR BEHIND THE BACK IS DANGEROUS

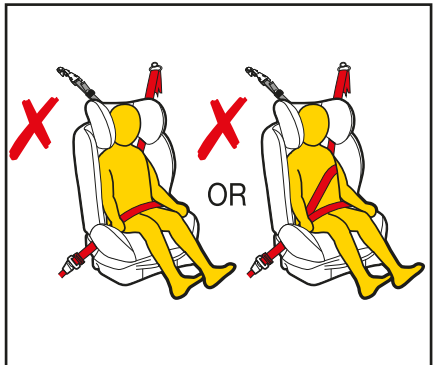

# Use

## To release child

**Step 1:** To release your child from the restraint simply press the belt buckle carefully remove your child from the seat. It is not necessary to release the red belt clamp, to remove your child.

When the restraint is not in use, the seat belt should be fastened around it and engaged.



### WARNING

- Always use lap-sash seat belt and upper anchorage strap to attach the child restraint to the vehicle.
- Do not use the restraint without the upper anchorage strap correctly attached and adjusted.
- Do not use on any vehicle seat which faces sideways or rearwards.
- IF AN AIRBAG IS FITTED IN THE SEATING POSITION WHERE THE CHILD RESTRAINT IS TO BE FITTED, FOLLOW THE VEHICLE MANUFACTURER'S WARNINGS AND INSTRUCTIONS.
- DO NOT USE WITH JUST A LAP BELT. You must use with a lap-sash seat belt.
- Ensure the lap belt is correctly positioned on the child's thighs and hips.
- Do not place the seat belt sash under the arm or behind the back of the child.

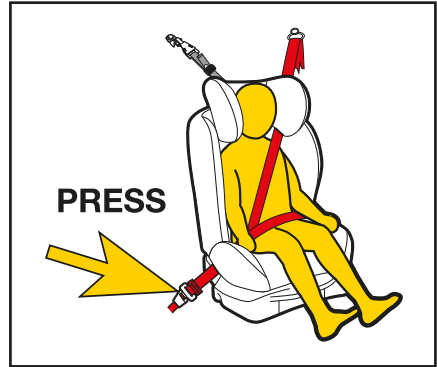

# Care of Restraint

The child restraint cover has been manufactured to meet the Australian Standards requirements for flammability and toxicity to ensure your child's safety. The cover has also been designed to provide your child with comfort and support.

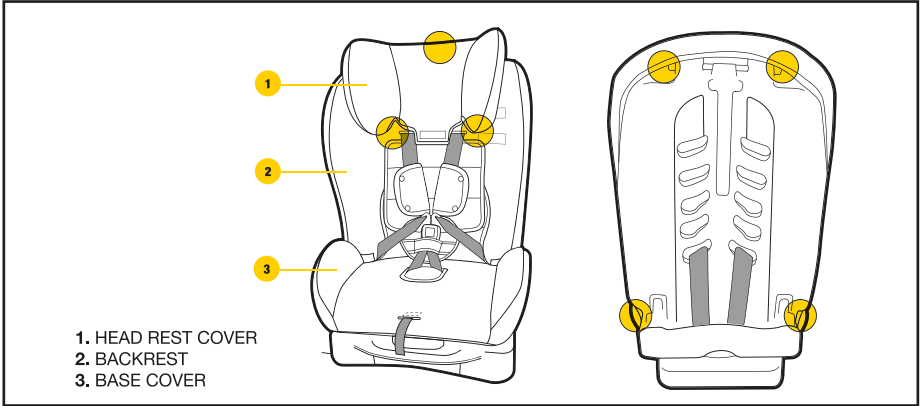

## VERY IMPORTANT

**Only replace the cover with a InfaSecure supplied replacement cover with identical shoulder height markers or a replacement cover meeting AS/NZS 8005.**

## Care and Maintenance

Regular care of the restraint will ensure safety of your child.

- Check the webbing for fraying.
- Check the upper anchorage attachment clip to ensure retainer clip is still present.
- Ensure there are no cracks in the plastic moulding.
- Check the buckles “click” when you engage tongues and is not sluggish or sticky in operation.
- Ensure the buckle is free of fluff, liquid, or other matter that may enter the buckle slots. Clean the buckle if it is sluggish to engage (refer Cleaning Buckle Page 57)
- Check the harness adjuster is operating and is clamping the webbing
- If any part of the restraint is cracked or broken, seek repair immediately or replace the child restraint.



# Care of Restraint

## **IMPORTANT**

Use only mild soap and water to clean all parts of the CS4313 Convertible Car Seat.  
Do not use chemicals or cleaning agents  
Cold water only to be used and to be rinsed well  
Do not dry clean or tumble dry  
Do not bleach.

### Care and Maintenance

The restraint has a flame retardant cover which is removable for cleaning. Cleaning instructions are on the care label attached to the cover. If a fluffy cover is fitted, then washing the cover prior to use will remove excess fluff.

The cover has been designed to protect your child when seated in the restraint. Care should be taken, if children either eat or drink while in the restraint, as some food or drink products may cause damage or marking to the cover. Wash or clean immediately.

Do not pull sticky items from covers as the cover may be damaged - soak in water and gently remove. Only machine wash on gentle cycle (hand washing is recommended). When washing the covers, ensure the hook and loop attachment strips are connected to eliminate other materials or garments being caught. Ensure that the hook and loop attachment strips are free of lint, this will ensure a positive engagement.

## **IMPORTANT**

For **Velour** or **Leatherette** fabric only sponge clean with a damp cloth.

### Seat & Hardware

Use only mild soap and water to clean all webbing, metal and plastic parts of the restraint using a damp cloth.  
Do not use chemicals or cleaning agents.

### Harness Straps

Use only mild soap and water to clean all straps, using a damp cloth, you should avoid soaking the harness straps however they must be thoroughly dried (without excessive heat or never tumble dry). The harness straps should not be placed in a washing machine as this may cause damage to the stitching or even damage your washing machine.  
Do not use chemicals or cleaning agents.

# Cleaning

## Harness Buckle

If sticky liquids such as baby formula, fruit juice, etc. get inside your Harness Buckle, it may become sluggish. An indication of a sluggish Harness Buckle is that you cannot hear a **“CLICK”** when engaging the Harness Tongues. To restore the Harness Buckle to good working order it needs to be cleaned as follows:

**Step 1:** From the underside of the restraint pull each crotch 3-bar slide then turn 3-bar slide and push through each slot to remove the Harness Buckle from the restraint (refer Figure 1).

**Step 2:** Place the Harness Buckle under warm (max. 40 degrees Celsius) running water as shown below. Let the water run through the mouth of the buckle for five minutes (refer Figure 2).

**Step 3:** Engage and disengage the Harness Tongues and Buckles several times until a strong audible **“CLICK”** is heard when inserting the last tongue (refer Figure 3).

**Step 4:** If you still cannot hear a strong audible click after engaging the Harness Tongues and Buckle, then repeat cleaning several times. If the Harness Buckle cannot be returned to its original working condition then contact InfaSecure Customer Care 02 4728 8090.

**Step 5:** Refit the harness buckle to the restraint with the red button facing out and feeding each 3-bar slide through appropriate slot. Always ensure the webbing crotch straps are thoroughly dried before installing.

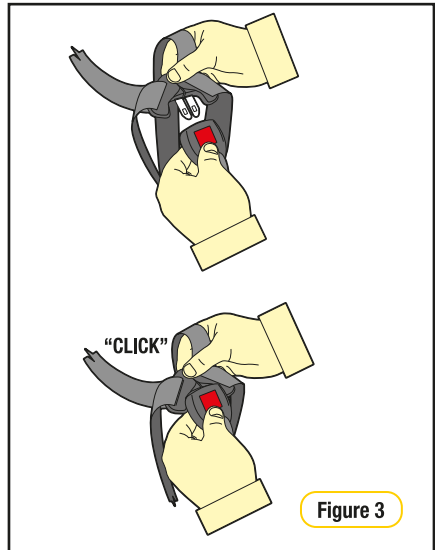
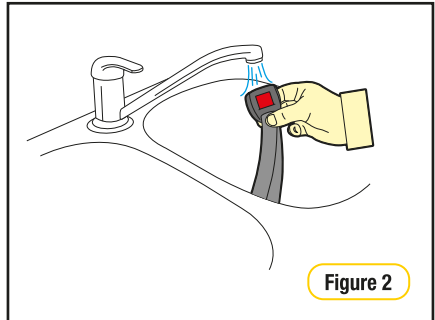
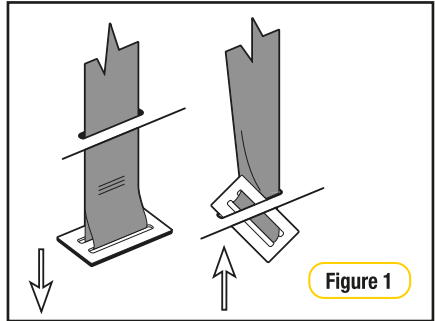

Harness Buckle Care

# Cleaning

## Remove covers

**Step 1:** To remove headrest cover unclip 4 press studs located on the headrest.

**Step 2:** Slide the harness shoulder straps out through the gates in the metal spreader plate.

Pull the harness shoulder straps through the shoulder slots to the front of the restraint.

**Step 3:** Disengage the buckle and tongues. Push the buckle through the crotch slot in the cover.

**Step 4:** To remove seat back cover, first unclip the 2 press studs located either side of the seat and 2 press studs behind the headrest also 2 elastic loops at the back of the cover. Do NOT remove the harness from under the seat. (Centre slot will enable removal over headrest).

**Step 5:** To remove seat base cover, first unclip the 2 press studs located either side of the seat cover.

**Step 6:** Once cover is removed, “click” the buckle tongue back into the buckle for safe keeping.

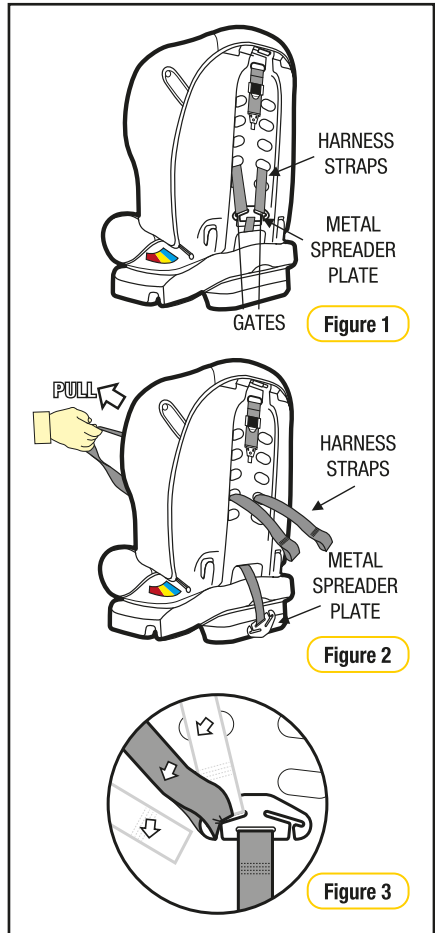

## Replace covers

**Step 1:** Reverse the ‘Remove Covers’ process

# Extension Straps

If required contact InfaSecure for nearest supply location. Extension straps, not included in this package, may be required for vehicles without a fixed parcel shelf.

## Re order Line Numbers

- CS111 300mm Length
- CS112 600mm Length
- CS113 200mm - 900mm Adjustable Length

If required contact Infa Secure Customer Care 02 4728 8090 for nearest supply location.

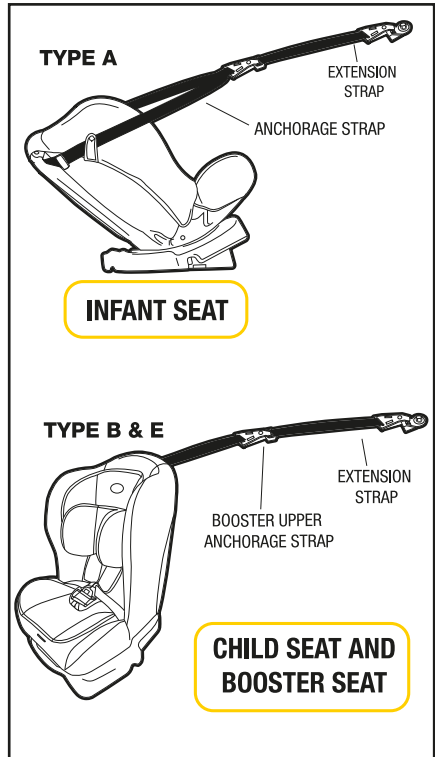

# Accessories

Follow the instructions covering the use of accessories provided with this child restraint or spare parts provided by InfaSecure for this restraint.

## **IMPORTANT**

Use of unauthorised aftermarket accessories (i.e items not provided in this box with the child restraint), can reduce the safety provided by the child restraint and may cause injury or death.

### **PADDED INSERTS** (if fitted)

The padded inserts are designed to add extra comfort for your child.

**Step 1:** Press to release Buckle tongues.

**Step 2:** Open the “press studs” and position the padded insert in the seat.

**Step 3:** Pass the harness straps over the insert and connect the “press studs”.

**Step 4:** Pull the Buckle and leg straps through the slot or opening in the insert.

**Step 5:** Connect both tongues into the buckle.

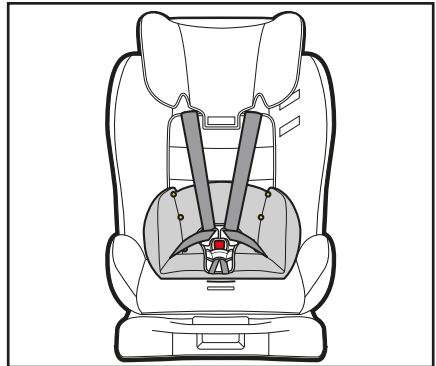

### **BUCKLE PAD** (if fitted)

The buckle pad is designed to add extra comfort for baby or child.

**Step 1:** Position the buckle pad behind the buckle and clip in the front. The release button should be clearly visible.

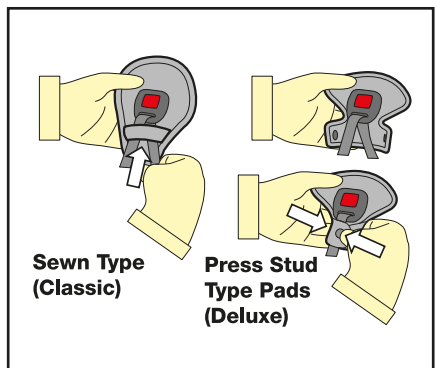

# Accessories

## SHOULDER PADS (if fitted)

The shoulder pads are designed to add extra comfort for baby or child.

### Classic

**Step 1:** Loosen harness to allow spreader plate to rise from under the restraint. Turn the restraint so that the back of the seat is facing you.

**Step 2:** Remove each shoulder harness through the gates in the spreader plate (refer Figure 1 & 2).

**Step 3:** Pull the shoulder harness straps through the shoulder slot holes in the seat body and cover. They are now loose in the front of the seat (refer Figure 2).

**Step 4:** To attach shoulder pads, slide the shoulder pad over the harness straps (refer Figure 3).

**Step 5:** Rethread harness straps (in applicable slots) as per Steps 1 to 3 above.

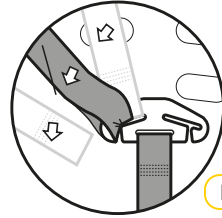

Figure 1

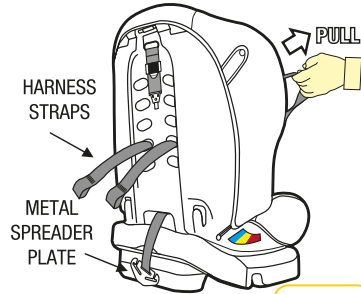

Figure 2

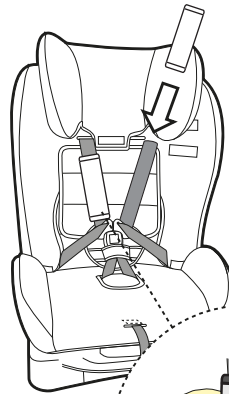
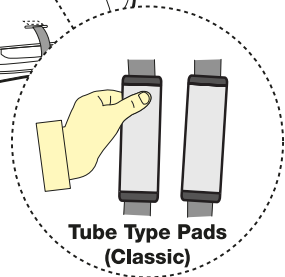

Figure 3



# Accessories

## SHOULDER PADS (if fitted)

### Deluxe

**Step 1:** Separate press-studs and remove the shoulder pads from harness

**Step 2:** To attach shoulder pads, ensure press studs face away from the child and re-attach.

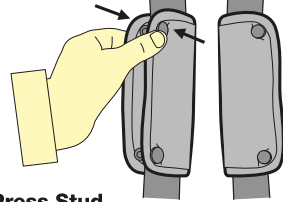

**Press Stud  
Type Pads (Deluxe)**

## SEAT PROTECTOR (if fitted)

The seat protector is designed to protect your car's seat.

### STANDARD

**Step 1:** Position the front flap with pockets, at the front of the rear seat and position the mat rearwards to obtain a flat fit.

### FULL LENGTH

**Step 1:** Position the front flap with pockets, at the front of the rear seat and position the mat rearwards to obtain a flat fit. (If required an additional flap has been provided to tuck in between the seat back & cushion)

**Step 2:** Position the back section up the seat back and use the plastic buckle & webbing strap to attach around the vehicle seat headrest (if the rear vehicle seat does not have a headrest then the strap could be used to attach around the child seats top tether after you have installed the child seat).

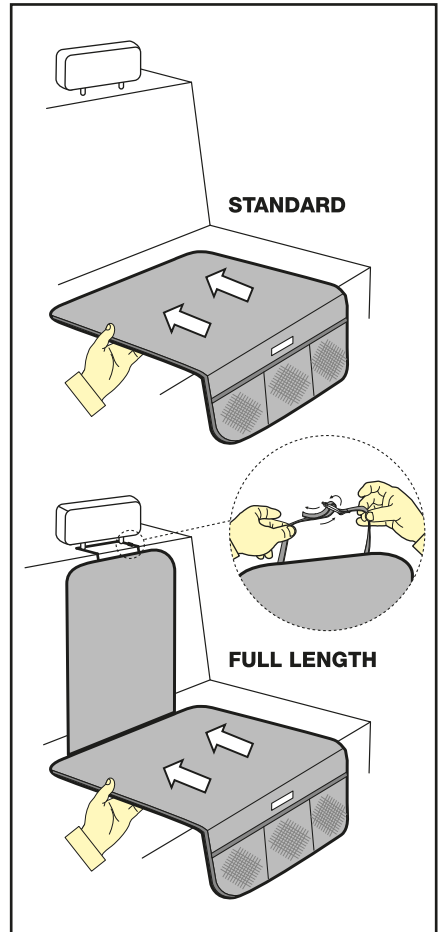

# Anchorage Fittings

Some vehicles may have an anchor fitting already fitted by the vehicle manufacturer.

If no anchorage points can be found refer to the vehicle manufacturer, or an authorised child restraint fitting station for the best location of an anchorage point.

Refer to the vehicle owners handbook or child restraint fitting station for the possible use of spacers.

Some vehicles may require the use of additional extension straps (not supplied with this child restraint)

If so ring InfaSecure on (Aust) (02) 4728 8090 for nearest supply location.

## ADDITIONAL EXTENSION STRAPS AVAILABLE:

- CS111 300mm Extension strap
- CS112 600mm Extension strap
- CS113 200 - 900mm Adjustable Extension strap



- Top tether strap and attachment clip must always be used
- Always ensure that the upper attachment clip is correctly engaged to the anchor fitting
- **THIS RESTRAINT MUST BE ATTACHED TO A CHILD RESTRAINT ANCHORAGE POINT IN THE CAR. REFER TO CAR OWNER'S HANDBOOK FOR LOCATION OF ANCHORAGE POINTS. REFER TO A CHILD RESTRAINT FITTING STATION IF NO CAR ANCHORAGE POINTS ARE IN THE MOTOR CAR.**
- **THIS RESTRAINT IS NOT SUITABLE FOR USE WHERE TOP TETHER STRAP MAY FALL INTO A SPLIT IN THE SEAT BACK OR OFF THE SIDE OF THE SEAT.**



# Anchorage Fittings

## For cars fitted with a child restraint anchorage point

THIS RESTRAINT MUST BE ATTACHED TO A CHILD RESTRAINT ANCHORAGE POINT IN THE CAR.

LOCATE THE ANCHORAGE POINT BEHIND THE REAR SEATING POSITION.

CONSULT THE CAR OWNER'S HANDBOOK FOR LOCATION OF ANCHORAGE POINTS.

REMOVE THE THREAD PLUG FROM THE PARCEL SHELF/FLOOR/ROOF AND INSTALL THE ATTACHMENT BOLT AS SHOWN IN FIGURE 1A & 1B.

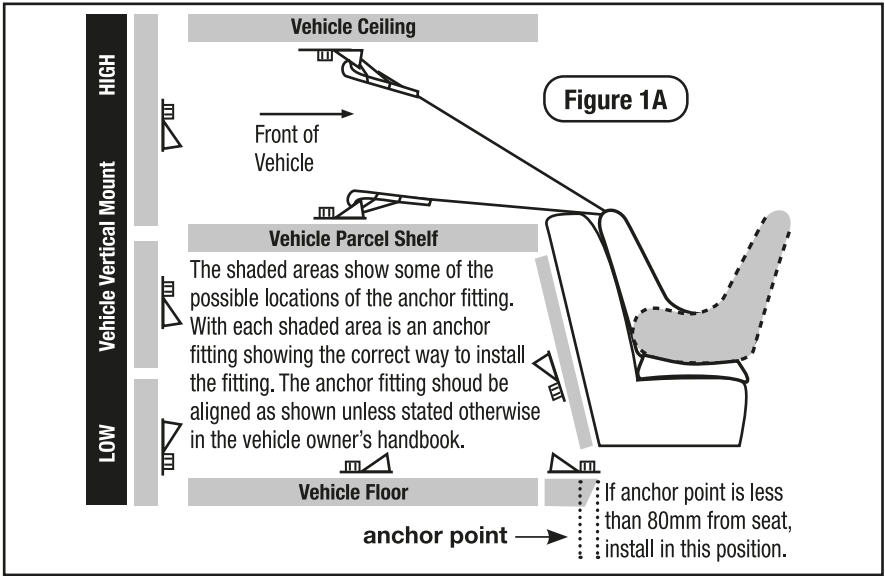

**CAUTION: DO NOT OVERTIGHTEN ATTACHMENT BOLT. MAXIMUM TORQUE IS 20NM.**

**WARNING:** If A.D.R. anchorage point is recessed, spacer(s) may be required. Spacer Part No's are as follows:

- 10mm - CCS001
- 5mm - CCS002

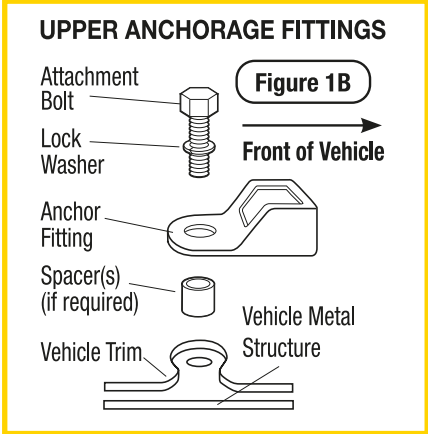

# Anchorage Fittings

**For cars not fitted with a child restraint anchorage point**

## For Sedans Only

Drill a 9mm diameter hole in the parcel shelf on the centre line of the seating position as shown in Figure 1C. Hole must be no closer than 200mm from the front of the back seat. Install the anchor bolt as shown in Figure 1D.

Note to Queensland purchases: The installation of anchorage points must be approved by authorised officers appointed by Queensland Transport. Authorised officers can be sourced from all Queensland Transport Customer Service and Queensland Ambulance Service Centres.

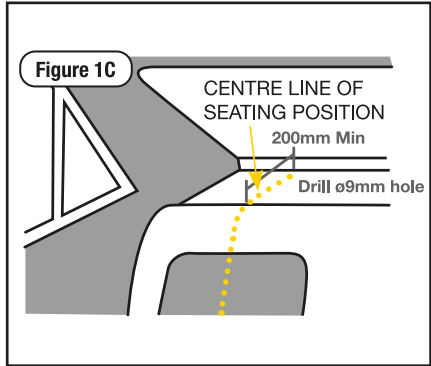

## For Vehicles other than Sedans

In Australia, consult your nearest child restraint fitting station of traffic authority for vehicle inspection to find the best, correct position for the placement of the anchorage point, and for the correct attachment bolt length use of spacers.

In New Zealand consult the agent of the vehicle.

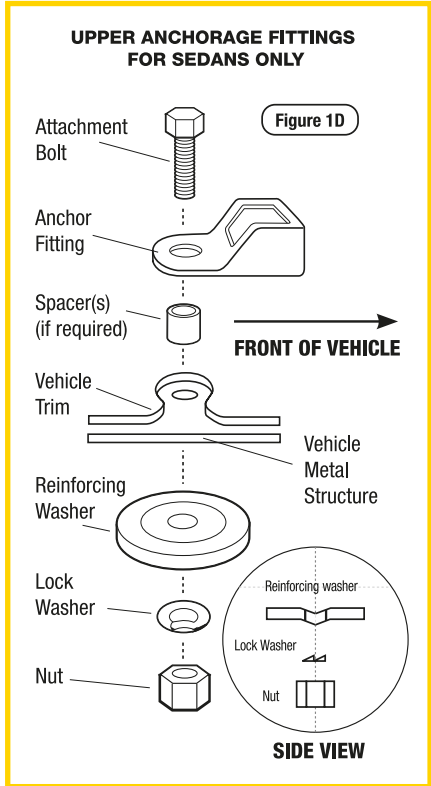

## ⚠ WARNINGS

CHILD RESTRAINTS MUST NOT BE ATTACHED TO UNSOUND METAL OR WOOD OR SYNTHETIC STRUCTURES. WHEN DRILLING THE 9MM HOLE DO NOT DRILL THROUGH FUEL LINES, FUEL TANKS, ELECTRICAL WIRING OR RADIO SPEAKERS. WEBBING STRAPS MUST BE PROTECTED FROM SHARP CORNERS AND EDGES.

THE ANCHOR FITTING MUST BE USED ONLY AS DESCRIBED ABOVE. IT MUST NOT BE HOOKED ONTO ANY OTHER OBJECT.

# Insurers Information

If your restraint has been involved in a severe crash, you should destroy the restraint even if no damage is obvious. Some insurance companies offer vehicle insurance which covers or partially covers the replacement of your child restraint. Contact your insurance company for further details.

Your insurance company may require you to keep the child restraint for assessment, but do not use the child restraint after a severe crash. To assist you in making an accident insurance claim cut the following statement and include it with your claim.

## **NOTICE TO INSURANCE COMPANY CHILD RESTRAINT INVOLVED IN AN ACCIDENT**

All InfaSecure child restraints are manufactured to Australian/New Zealand Standards AS/NZS1754 which requires us to advise users of child restraints to "Destroy the entire restraint if it has been in use in a severe crash, even if no damage is obvious". The Australian/New Zealand Standards committee, advise that this statement applies whether a child was in the child restraint or not. We consider a "severe crash" as being one where the main body structure of the vehicle is distorted. There is no method of determining if the restraint has been damaged and we concur with the Australian/New Zealand Standards in recommending destruction of the child restraint. This notice is to advise you of the requirements of the Australian/New Zealand Standards and our obligation in complying with the standards. Please assist the owner of this restraint in their claim.

**INFASECURE PTY LTD** ABN: 52 149 173 660

Head Office and Registered Address  
110-114 Old Bathurst Rd, Emu Plains, NSW 2750  
P.O. Box 487, Emu Plains, NSW 2750

Head Office  
**P:** 02 4728 8000  
**F:** 02 4728 8040

[www.infasecure.com.au](http://www.infasecure.com.au)



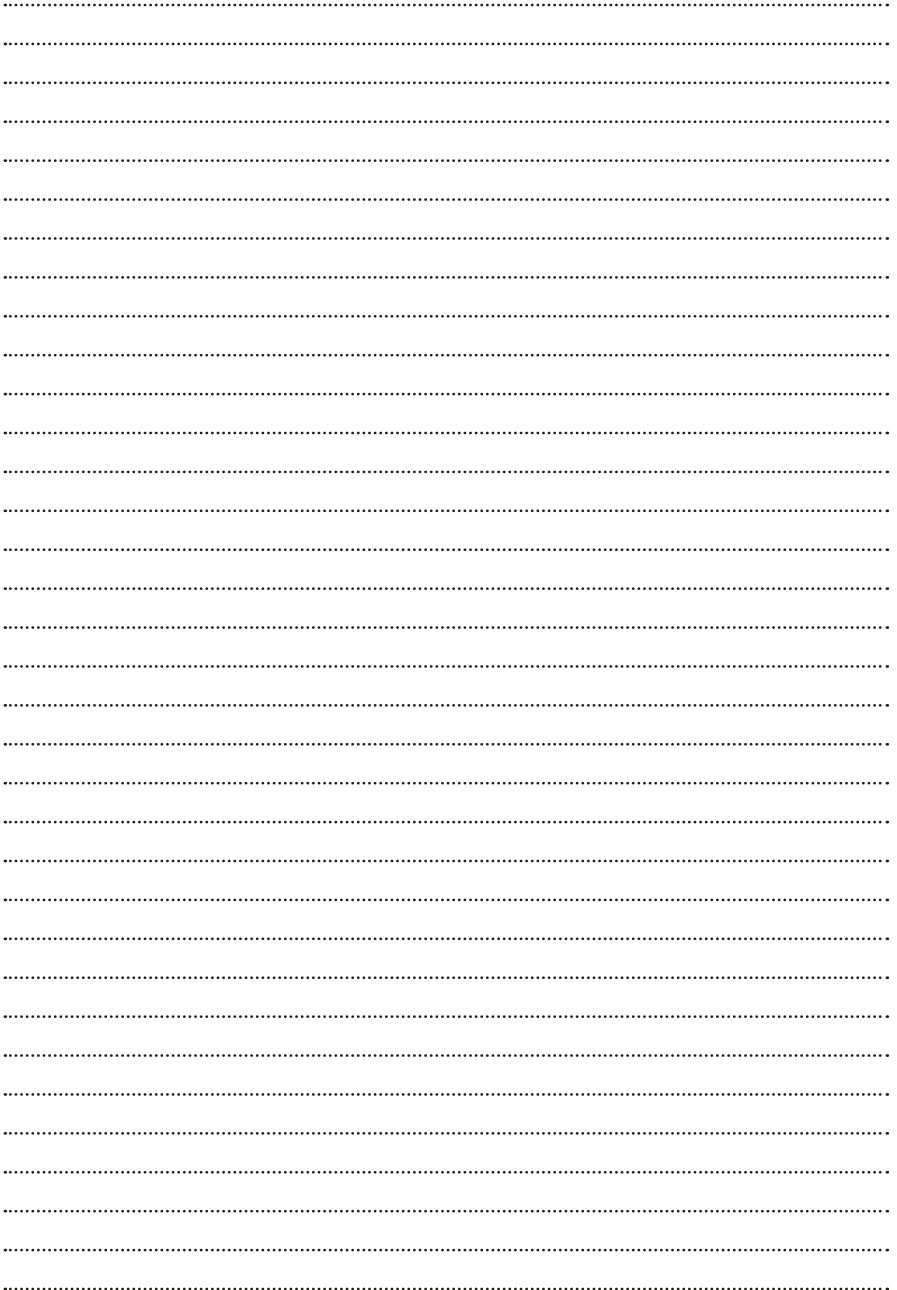

# Notes:

A series of 30 horizontal dotted lines, evenly spaced, spanning the width of the page. These lines are intended for writing notes.

# Notes:

.....  
.....  
.....  
.....  
.....  
.....  
.....  
.....  
.....  
.....  
.....  
.....  
.....  
.....  
.....  
.....  
.....  
.....  
.....  
.....  
.....  
.....  
.....  
.....  
.....  
.....  
.....  
.....  
.....  
.....  
.....  
.....  
.....  
.....  
.....  
.....  
.....  
.....  
.....  
.....  
.....  
.....  
.....  
.....  
.....  
.....  
.....  
.....  
.....  
.....  
.....

# LIFETIME WARRANTY

ON SUPER STRONG BLOW MOULDED SHELL PRODUCTS

Register your product to receive lifetime warranty\*, product updates and information.



Please visit [infasecure.com.au/warranty-registration](https://www.infasecure.com.au/warranty-registration) to register your product.

## Infasecure Warranty

Infasecure Pty Ltd warrants this product for twelve months from the date of purchase against failure due to manufacturing faults or faulty materials. Misuse, accidental damages, normal wear and tear are not covered by this warranty. When used for commercial use the period is limited to six months. “Our goods come with guarantees that cannot be excluded under the Australian Consumer Law. You are entitled to a replacement or refund for a major failure and for compensation for any other reasonably foreseeable loss or damage. You are also entitled to have the goods repaired or replaced if the goods fail to be of acceptable quality and the failure does not amount to a major failure.”

## Additional Warranty on Blow Moulded Child Restraints

Our blow moulded child restraints are covered against faulty materials and manufacturing when used under normal conditions and according to the instructions.

In the unlikely case that you do have a fault in relation to material quality or manufacturing that restricts your ability to use your Child Restraint normally, we will repair or replace the product within the following warranty periods from date of purchase:

- 12 month warranty for material and fabrics
- 2 year warranty for straps and webbing
- 5 year warranty for hardware and fittings
- Lifetime warranty\* on the manufacturing of the seat moulding

Please read your instruction manual carefully before using any of our products. The above express warranties do not apply where a failure or defect results from improper care, misuse or from normal wear and tear.

Refer to website for more details: [www.infasecure.com.au](https://www.infasecure.com.au)

\*Lifetime warranty refers to the life span of the seat which is 10 years from the Date of Purchase.



CHILD RESTRAINT SAFETY PARTNER



“ We are proud to be working with The Wiggles. With their help, we are able to reach more young families with much needed information and advice to keep our little ones safe. ”

**INFASURE PTY LTD** ABN: 52 149 173 660

Head Office and Registered Address  
110-114 Old Bathurst Rd, Emu Plains, NSW 2750  
P.O. Box 487, Emu Plains, NSW 2750

HEAD OFFICE

**Phone No:** +61 2 4728 8000

**Fax No:** +61 2 4728 8040

**Email:** admin@infa.com.au

CUSTOMER CARE

**Phone No:** +61 2 4728 8090

**Fax No:** +61 2 4728 8040

**Email:** service@infa.com.au



**Australian  
Standard**

AS/NZS: 1754:2013  
Licence No. 25324-1  
SAI Global

**ISSUE: D**