

CS7110 CS7210 MODELS



Convertible Booster Seat

CHILD SEAT TO BOOSTER SEAT



CHILD SEAT

(Forward Facing)
Suitable for children
from approximately
6 months to 4
years* of age



BOOSTER SEAT

Suitable for children
approximately
4 to 8 years* of age



Australian
Standard

AS/NZS: 1754-2010
Licence No. 25324
SAI Global

The photo displayed is indicative of the type of restraint and may vary slightly depending on the model.

⚠ IMPORTANT

KEEP THIS BOOKLET IN THE PROVIDED ON THE CHILD RESTRAINT

CS7110 CS7210 MODELS

SUITABILITY OF THE CHILD RESTRAINT TO GROUPS OF CHILDREN

The CS7110/CS7210 Convertible Car Seat is suitable for toddlers and older children as a convertible booster seat.

CONVERTIBLE BOOSTER SEAT (Type B and Type E)

Child Seat to Booster Seat

To be used in forward-facing position with built-in harness by children whose shoulders are above the lower shoulder height marker (approximately 6 months of age) until their shoulders reach the middle shoulder height marker (approximately 4 years of age). Then to be used with a lap-sash seat belt until their shoulders reach the upper shoulder height marker (approximately 6 to 8 years of age).

Continue to use this child restraint until the child reaches this limit.

Children are safest in a booster seat until their shoulders reach the upper shoulder height marker of the booster seat.

Do not use this child restraint until child's shoulders are above the lower shoulder height marker.

Just using a seat belt is not recommended for children that have outgrown this seat. Use a larger booster seat.



IMPORTANT

PLEASE READ AND FOLLOW THESE INSTRUCTIONS EXACTLY BEFORE INSTALLATION PLEASE READ CAREFULLY THE WHOLE OF THE INSTRUCTIONS FOR INSTALLATION AND IF IN THE EVENT OF DOUBT ABOUT THE METHOD OF INSTALLATION TO CONSULT INFASECURE OR A CHILD RESTRAINT FITTING STATION AUTHORISED BY THE RELEVANT TRANSPORT AUTHORITY. IN NEW ZEALAND, CONSULT THE AGENT FOR THE VEHICLE.



WARNING

DO NOT LEAVE CHILDREN UNATTENDED IN THE CAR.



INFASECURE PTY LTD

P.O. Box 487, Emu Plains
NSW 2750

Customer Service
Phone No: 02 4728 8090

Contents

Suitability of the child restraint	Page 1
Contents	Page 2
ANCHORAGE FITTINGS	
- For cars fitted with anchorage points	Page 3
- For cars not fitted with anchorage points	Page 4
Restraint Guide	Page 5
Padding - Combination Guide	Page 6

CHILD SEAT

- Information & Warnings	Page 7
- CS7110/CS7210 Child Restraints (Itemised list)	Page 8
- Shoulder Height Marker	Page 9-10
SET UP	
- Selection of Appropriate Padding Combination	Page 11
- Adjusting Recline Angle	Page 11
- Correct Shoulder Height	Page 11
- Shoulder Slot Height	Page 11
INSTALLATION	
- Installing in Vehicle (using lap-sash seat belt)	Page 12-14
- Installing in Vehicle (using lap seat belt)	Page 14
USE	
- Using Inbuilt Harness	Page 15
- To Release Child	Page 15

BOOSTER SEAT

- Information & Warnings	Page 16
- Shoulder Height Marker	Page 17-18
- CS7110/CS7210 Child Restraints (Itemised list)	Page 19
SET UP	
- Selection of Appropriate Padding Combination	Page 20
- Converting to Booster	Page 20
INSTALLATION	
- Installing in Vehicle	Page 21
USE	
- Using Lap-Sash Seat Belt	Page 22-23
- To Release Child	Page 24

CARE OF RESTRAINT

- To Remove Harness / To Replace Harness	Page 25
- To Remove Cover / To Replace Cover	Page 25
- Cleaning / Care and Maintenance	Page 26-28
EXTENSION STRAPS	Page 28
ACCESSORIES	Page 28-30

ANCHORAGE FITTINGS

Some vehicles may have an anchor fitting already fitted by the vehicle manufacturer.

If no anchorage points can be found refer to the vehicle manufacturer, or an authorised child restraint fitting station for the best location of an anchorage point.

Refer to the vehicle owners handbook or child restraint fitting station for the possible use of spacers.

Some vehicles may require the use of additional extension straps (not supplied with this child restraint)

If so ring InfaSecure on (Aust) (02) 4728 8080 for nearest supply location.

ADDITIONAL EXTENSION STRAPS AVAILABLE:

CS111 300mm Extension strap

CS112 600mm Extension strap

CS113 200 - 900mm Adjustable Extension strap



WARNING

- Upper anchorage strap and attachment clip must always be used
- Upper Anchorage strap and attachment clip must only be attached to the correct anchor fitting
- Always ensure that the upper attachment clip is correctly engaged to the anchor fitting
- This restraint is not suitable for use in a hatchback or wagon where the anchorage strap may fall into a split in the seat back
- Straps may be damaged by unsecured cargo in a collision. Secure or remove hazardous cargo before using this restraint. Hatch-back or wagon: Do not use the child restraint where this strap may fall into a split in the seat back. Always attach hook and remove slack.

FOR CARS FITTED WITH A CHILD RESTRAINT ANCHORAGE POINT

THIS RESTRAINT MUST BE ATTACHED TO A CHILD RESTRAINT ANCHORAGE POINT IN THE CAR.

LOCATE THE ANCHORAGE POINT BEHIND THE REAR SEATING POSITION

CONSULT THE CAR OWNER'S HANDBOOK FOR LOCATION OF ANCHORAGE POINTS.

REMOVE THE THREAD PLUG FROM THE PARCEL SHELF/FLOOR/ROOF AND INSTALL THE ATTACHMENT BOLT AS SHOWN IN FIGURE 1A & 1B.

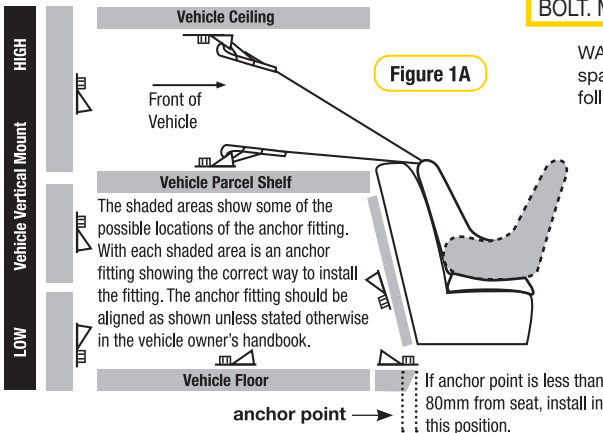

CAUTION: DO NOT OVERTIGHTEN ATTACHMENT BOLT. MAXIMUM TORQUE IS 20NM.

WARNING: If A.D.R. anchorage point is recessed, spacer(s) may be required. Spacer Part No's are as follows: 10mm - CCS001; 5mm - CCS002

UPPER ANCHORAGE FITTINGS

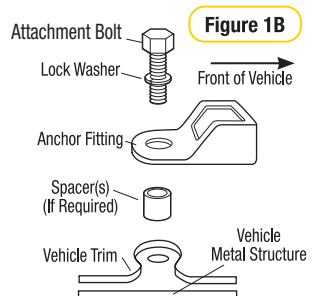

ANCHORAGE FITTINGS

FOR CARS NOT FITTED WITH A CHILD RESTRAINT ANCHORAGE POINT

FOR SEDANS ONLY

Drill a 9mm diameter hole in the parcel shelf on the centre line of the seating position as shown in Figure 1C. Hole must be no closer than 200mm from the front of the back seat. Install the anchor bolt as shown in Figure 1D.

Note to Queensland purchasers: The installation of anchorage points must be approved by authorised officers appointed by Queensland Transport. Authorised officers can be sourced from all Queensland Transport Customer Service and Queensland Ambulance Service Centres.

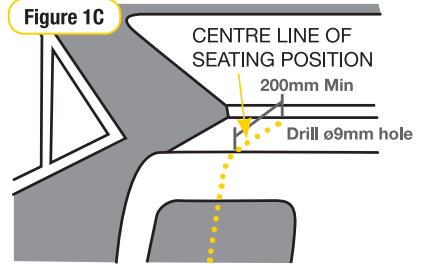

FOR VEHICLES OTHER THAN SEDANS

In Australia, consult your nearest child restraint fitting station or traffic authority for vehicle inspection to find the best, correct position for the placement of the anchorage point, and for the correct attachment bolt length and use of spacers.

In New Zealand consult the agent of the vehicle.



WARNING

CHILD RESTRAINTS MUST NOT BE ATTACHED TO UNSOUND METAL OR WOOD OR SYNTHETIC STRUCTURES. WHEN DRILLING THE 9MM HOLE DO NOT DRILL THROUGH FUEL LINES, FUEL TANKS, ELECTRICAL WIRING OR RADIO SPEAKERS. WEBBING STRAPS MUST BE PROTECTED FROM SHARP CORNERS AND EDGES.

THE ANCHOR FITTING MUST BE USED ONLY AS DESCRIBED ABOVE. IT MUST NOT BE HOOKED ONTO ANY OTHER OBJECT.

UPPER ANCHORAGE FITTINGS FOR SEDANS ONLY

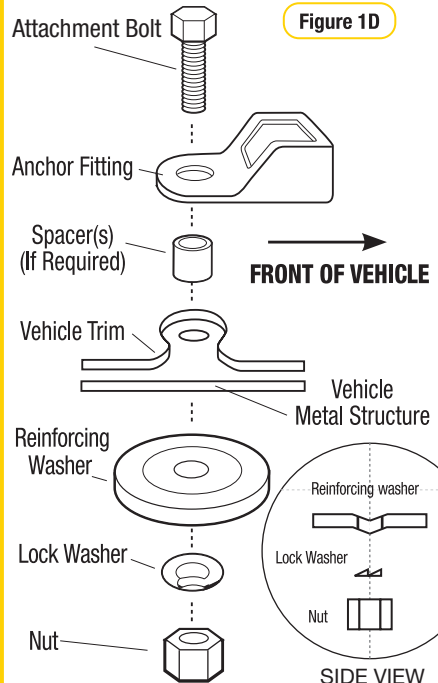

RESTRAINT GUIDE

INFANT SEAT

CHILD SEAT

BOOSTER SEAT

MODE

BIRTH 2 4 6 8 10 12+

REARWARD-FACING RESTRAINT (TYPE A1)
BIRTH TO APPROX 6 MONTHS



REARWARD FACING

0 to 6 (months)



CONVERTIBLE CAR SEAT (TYPE A2/B)
BIRTH TO 4 YEARS



REARWARD FACING

FORWARD FACING

Approx 0 to 4 years

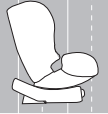

ZERO TO 8 CONVERTIBLE CAR SEAT (TYPE A1/B/E)
BIRTH TO 8 YEARS



REARWARD FACING

FORWARD FACING

BOOSTER SEAT

Approx 0 to 8 years

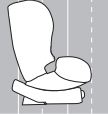

FORWARD-FACING RESTRAINT (TYPE B)
APPROX 6 MONTHS TO 4 YEARS



FORWARD FACING

Approx 6 months to 4 years

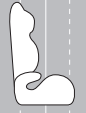

CONVERTIBLE BOOSTER SEAT (TYPE B/E)
APPROX 6 MONTHS TO 8 YEARS

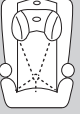

FORWARD FACING

BOOSTER SEAT

Approx 6 months to 8 years



BOOSTER SEAT (TYPE E)
FROM APPROX 4 YEARS 8 YEARS



BOOSTER SEAT

Approx 4 years to 8 years



CHILD SAFETY HARNESS (TYPE C)
FROM APPROX 4 TO 7 YEARS



CHILD HARNESS SHOULD ONLY BE USED IF A LAP ONLY SEAT BELT IS AVAILABLE

Approx 4 to 7 years
(with Booster seat and lap-belt only)

Approx 7 to 10 years
(without Booster seat and lap-belt only)

SECUREFIT (ACCESSORY) SAFETY RETAINING DEVICE
FROM APPROX 4 TO 7 YEARS



ONLY USE WITH INFASecure BOOSTER SEATS

Approx 4 to 7 years
(with InfaSecure Booster seat)
*Not applicable for 2004 Standard models

SEAT BELT
FROM APPROX 7 YEARS AND OVER



7 +

10 +

Allowable by law

More Appropriate

IMPORTANT

Research has shown that the likelihood of an accessory child safety harness being used incorrectly is very high and the risk of injuries when incorrectly used is much higher compared to a lap-sash seat belt. InfaSecure recommend that an accessory child safety harness should only be used if a lap-only seat belt is all that is available.

PADDING/INSERTS

COMBINATION GUIDE

STANDARD

(Shoulder pads & buckle pads)

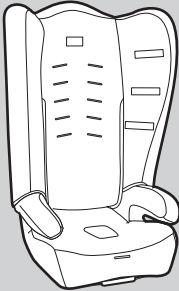
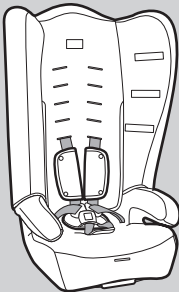
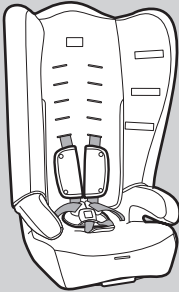

DELUXE

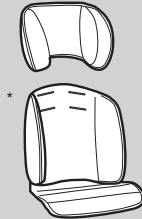

The Padded Insert/s (if fitted) are designed to provide extra support and comfort for small babies. Discontinue use when the insert is a tight fit or creates discomfort for larger children.

MODE

CHILD SEAT
(Small Child)
FORWARD FACING



CHILD SEAT
(Large Child)
FORWARD FACING



BOOSTER SEAT
FORWARD FACING



- *Diagrams are indicative of type of paddings and inserts and may not resemble the actual product.
- *Padded inserts can vary according to model (If supplied).
- We reserve the right to alter this product without notice.

*For detailed description and method of attachment for padded accessories refer to Accessories on page 31.

CHILD SEAT

(Forward Facing - using inbuilt harness)

CHILD
WITH INBUILT HARNESS

INFORMATION & WARNINGS

To be used only in a forward-facing position with built-in harness by children whose shoulders are above the lower shoulder height marker (approximately 6 months of age) until their shoulders reach the middle shoulder height marker (approximately 4 years of age).

TO BE USED WITH A LAP-SASH/LAP-ONLY SEAT BELT THE FRONT/BACK OF MOST CARS WITH FORWARD FACING SEATS.

Continue to use this child restraint until the child reaches this limit.

Do not use this restraint until child's shoulders are above the lower shoulder height marker.

Children are at risk of serious injury if they move to a booster seat too early. Children that have outgrown this restraint are safest in a booster seat until their shoulders reach the upper shoulder height marker of the booster seat.



WARNING

- Use the restraint exactly as shown in the instructions.
- Supervision of children is needed because they may be able to undo buckles.
- **DO NOT LEAVE CHILDREN UNATTENDED IN THE CAR.**
- Do not alter or modify this restraint.
- Repairs must only be done by the manufacturer or agent.
- Do not allow the restraint to come into contact with polishes, oils, bleach and other chemicals.
- Destroy the restraint if it has been in a severe crash, even if no damage is visible.
- Fit the restraint firmly to the car seat.
- Fit the harness firmly to the child.
- A loose restraint or harness is dangerous.
- **THIS RESTRAINT IS NOT SUITABLE FOR USE WHERE THE ANCHORAGE STRAP MAY FALL INTO A SPLIT IN THE SEAT BACK. (EG HATCHBACK OR WAGON)**
- **THIS RESTRAINT MUST BE ATTACHED TO A CHILD RESTRAINT ANCHORAGE POINT IN THE CAR. REFER TO CAR OWNER'S HANDBOOK FOR LOCATION OF ANCHORAGE POINTS. REFER TO A CHILD RESTRAINT FITTING STATION IF NO CAR ANCHORAGE POINTS ARE IN THE MOTOR CAR.**
- Straps may be damaged by unsecured cargo in a collision. Secure or remove hazardous cargo before using this restraint. Hatch-back or wagon: do not use the child restraint where this strap may fall into a split in the seat back. Always attach hook and remove slack.
- **IF AN AIRBAG IS FITTED IN THE SEATING POSITION WHERE THE CHILD RESTRAINT IS TO BE FITTED, FOLLOW THE VEHICLE MANUFACTURER'S WARNINGS AND INSTRUCTIONS.**
- When used in this mode the restraint must be used in conjunction with a lap or lap-sash seat belt.

MODEL CS7110/CS7210

CHILD
WITH INBUILT HARNESS

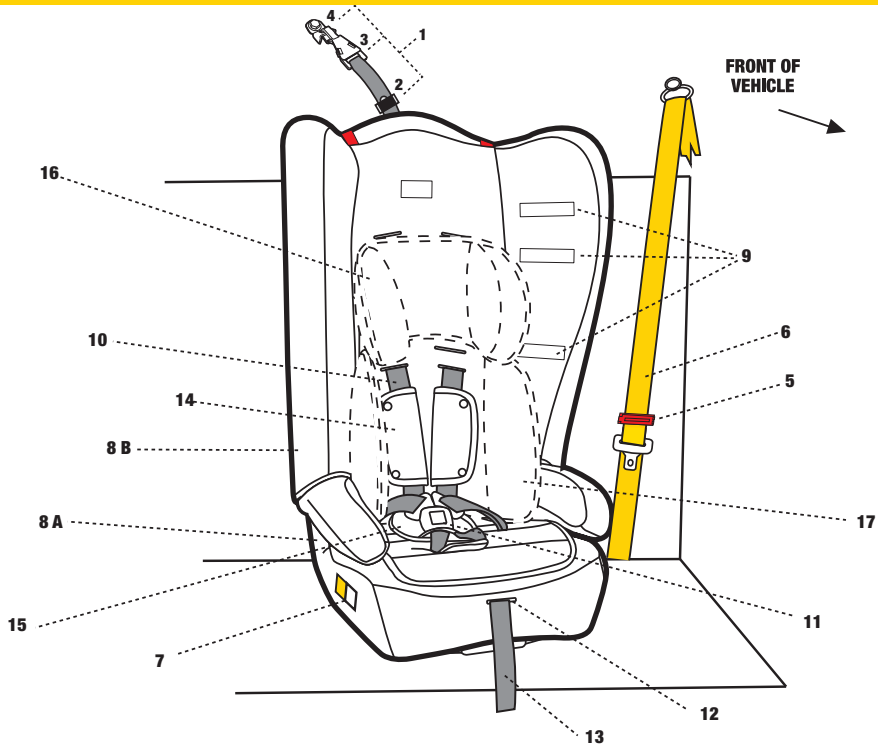

- | | |
|---|--|
| 1. UPPER ANCHORAGE STRAP ASSEMBLY | 9. SHOULDER HEIGHT MARKER |
| 2. UPPER ANCHORAGE STRAP ADJUSTER | 10. HARNESS SHOULDER STRAPS |
| 3. ATTACHMENT CLIP | 11. BUCKLE ASSEMBLY |
| 4. ANCHOR FITTING + ATTACHMENT HARDWARE | 12. HARNESS ADJUSTER |
| 5. SAFE GRIP RED BELT CLAMP (supplied in pocket) | 13. HARNESS ADJUSTMENT STRAP |
| 6. VEHICLE SEAT BELT | 14. SHOULDER PADS |
| 7. "FORWARD-FACING SEAT BELT PATH" MARKER (EACH SIDE OF RESTRAINT - COLOURED YELLOW) | 15. BUCKLE PAD |
| 8. COMFORT COVER
A - SEAT BASE
B - BACKREST | 16. PILLOW (if applicable) |
| | 17. PADDED INSERT (if applicable) |

IMPORTANT

For a vehicle without a fixed parcel shelf an extension strap(s) may be needed.

If so ring (02) 4728 8080 for nearest supply location. (Refer page 13)

Seat belt extenders should not be used if the seat belt is not long enough to secure the child restraint.

SHOULDER HEIGHT MARKER

CHILD
WITH INBUILT HARNESS

SMALLER TODDLER (Using Inbuilt Harness)

Shoulder height markers are provided on this restraint for a visual indication that the child is safe to travel in this restraint.
Shoulder height markers may be hidden under a pillow in the lowest position.

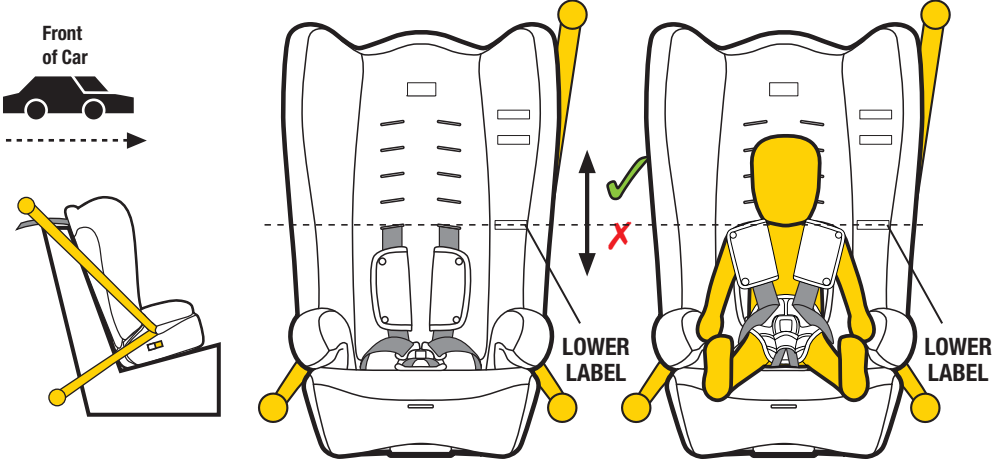

Smaller Toddler from
approximately 6 months of age

Do not use as a forward-facing child restraint until the child's shoulders are above the lower shoulder height marker (lower label).

LOWER LABEL (Forward Facing)

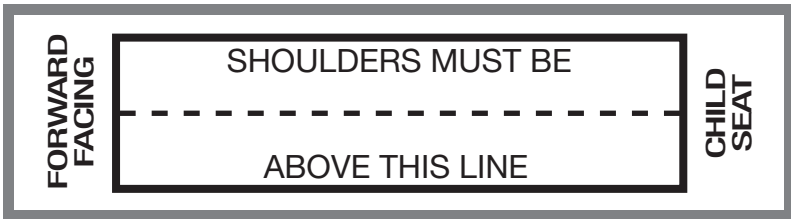

IMPORTANT

When using the inbuilt harness the child's shoulders must be in-line or above this marker

If moving a child from rearward-facing child restraint, to forward facing child restraint the child's shoulders will need to be in-line or above the lower label. If the child's shoulders are below the lower label or if the baby's neck muscles are unable to support their head, then the child should remain rearward-facing.

SHOULDER HEIGHT MARKER

CHILD
WITH INBUILT HARNESS

TALLER TODDLER (Using Inbuilt Harness)

Shoulder height markers may be hidden under a pillow in the lowest position

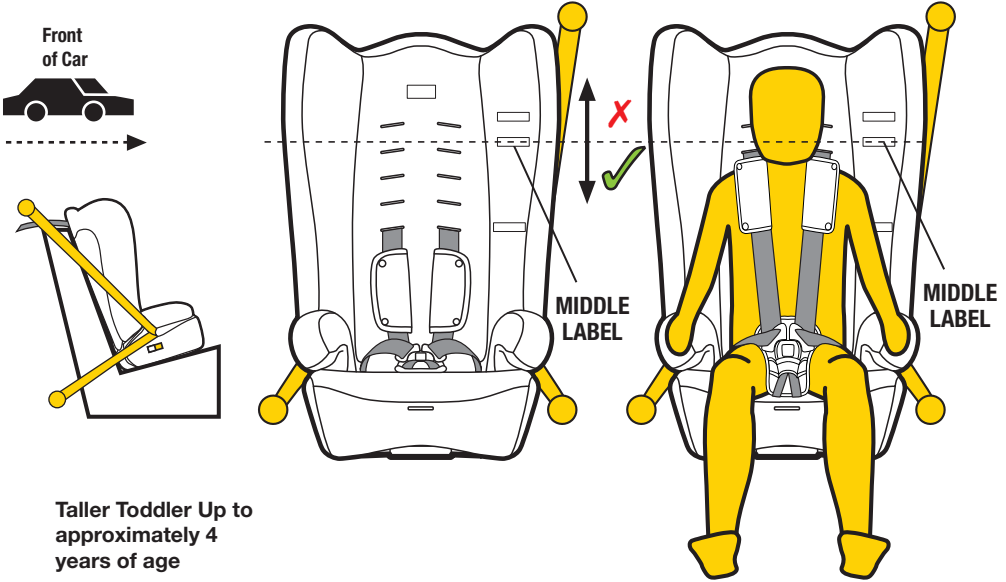

Taller Toddler Up to approximately 4 years of age

Continue to use this forward-facing child restraint until the child's shoulders reach the middle shoulder height marker, (Middle Label)

MIDDLE LABEL (Forward Facing)

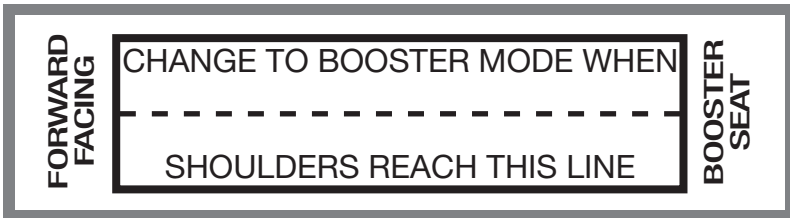

! IMPORTANT

When the child's shoulders reach the shoulder height marker (Middle Label), convert the child restraint to booster seat mode and use with a lap sash seat belt.

Children are at risk of serious injury if they move to booster seats too early.

Children that have outgrown the forward-facing child restraint are safest in a booster seat until their shoulders reach the upper shoulder height marker of the booster seat.

SET UP

CHILD
WITH INBUILT HARNESS

SELECTION OF APPROPRIATE PADDING COMBINATIONS

Step 1: Determine whether your child requires the additional padding provided with this restraint, to ensure a safe and snug fit in the restraint. Refer to page 6 for suggested padding combinations.

ADJUSTING RECLINE ANGLE

Determine which seat angle is preferred for the comfort of your child.

TO RECLINE

Pull down the recline base and ensure the support is forward (in position).

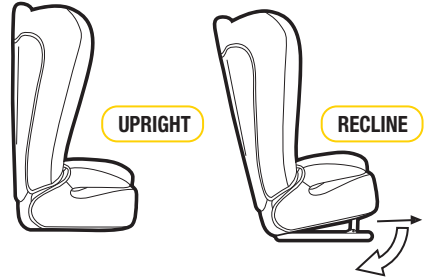

CORRECT SHOULDER HEIGHT

The correct height for the shoulder straps is very important for the optimum performance of the restraint. The shoulder straps must be in the slots which are nearest to the child's shoulders, but not more than 25mm below the child's shoulders (see figure 13).



IMPORTANT

The shoulder straps must be in the slots which are nearest to the child's shoulders, but not more than 25mm below the child's shoulders.

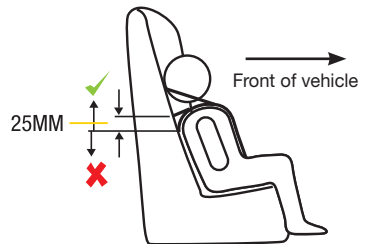

SHOULDER SLOT HEIGHT

With the child correctly sitting in the restraint, check which set of slots (in the plastic shell of the restraint) are the level with but not more than 25mm below the child's shoulders.

Step 1: From the rear of the restraint, remove each shoulder harness through the gates in the "G" connecting plate (see Figures 1, 2, 3 & 4).

Step 2: Pull the shoulder harness straps through the shoulder slot holes in the seat body and cover. They are now loose in the front of the seat (see Figure 5).

Step 3: Push the ends of the shoulder harness straps through the appropriate shoulder slot holes in the cover and seat body for the child's shoulder height. (see above for correct shoulder height for forward facing).

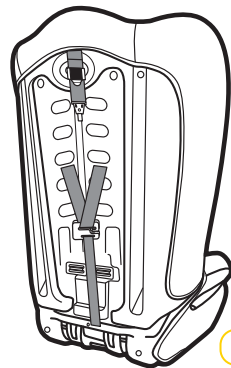

Figure 1

SET UP

SHOULDER SLOT HEIGHT

Step 4: Thread each shoulder harness strap back onto the “G” connecting plate through the gate (see Figure 3). The shoulder harness straps are connected to the “G” connecting plate (see Figure 2).



IMPORTANT

- Do not use the restraint with harness shoulder straps set at different heights.
- Ensure that all straps have been secured correctly by pulling on each strap.
- Ensure that the harness straps are not twisted.

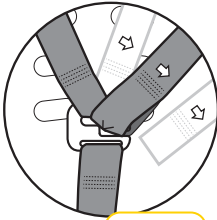

Figure 3

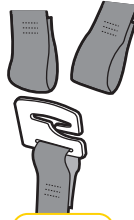

Figure 4

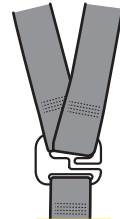

Figure 2

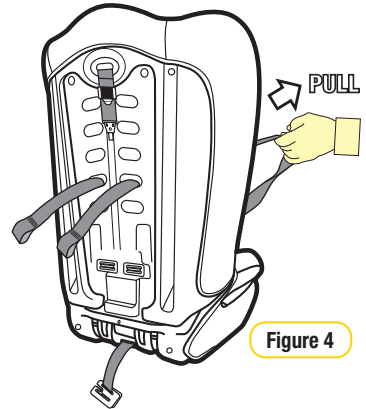

Figure 4

INSTALLATION

INSTALLING IN VEHICLE (Using Lap-sash Seat Belt)

Step 1: Place the child restraint in desired upright or reclined position, with the back against the back of the vehicle seat, directly in line with the anchorage point (see Figure 1).



IMPORTANT

Ensure that you use the **FORWARD-FACING BELT PATH** indicators, marked in “yellow”.

Step 2: Install the upper anchorage fitting as shown on page 3 & 4 of these instructions

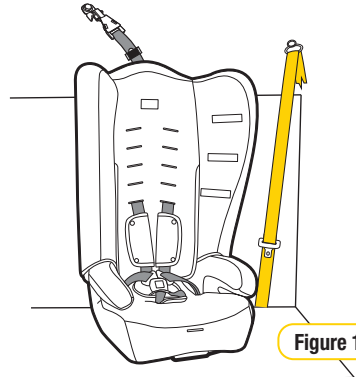

Figure 1

INSTALLATION

CHILD
WITH INBUILT HARNESS

INSTALLING IN VEHICLE (Using Lap-sash Seat Belt)

Step 3: Hook the attachment clip to the anchor fitting. Ensure there are no twists in the upper anchorage strap (Refer to Figure 2).

Step 4: Pull to tighten to remove all the slack, from the upper anchorage strap. Do not overtighten as this could cause the restraint to lift off the vehicle seat (Refer to Figure 3)

Step 5: Fold the rear of seat base cover and foam forward to expose the seating surface of the base. Fully extend the seat belt and pass the lap and sash sections of the vehicle belt under the first armrest, across the seat base ensuring you pass the seat belt beneath the tongue in the plastic moulding (refer Figure 4A) then under the second armrest, “click” the buckle into the buckle (Refer to Figure 4).

Important notes: The vehicle belt is now located across the seat base. The belt path is shown by the arrows in Figure 4 & 4A.

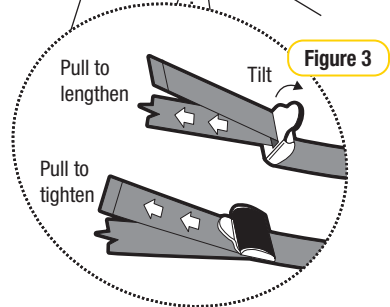
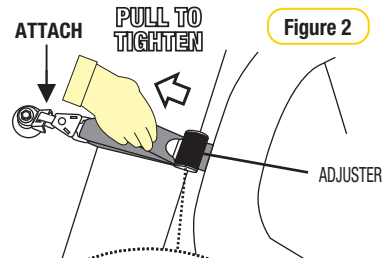

WARNING

- Always use a lap or lap-sash seat belt and upper anchorage strap to attach the child restraint to the vehicle.
- Do not use the restraint without the upper anchorage strap correctly attached and adjusted.
- Do not use on any vehicle seat which faces sideways or rearwards.
- IF AN AIRBAG IS FITTED IN THE SEATING POSITION WHERE THE CHILD RESTRAINT IS TO BE FITTED, FOLLOW THE VEHICLE MANUFACTURER'S WARNINGS AND INSTRUCTIONS.
- Fit the restraint firmly to the car seat.

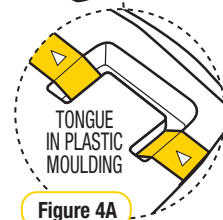
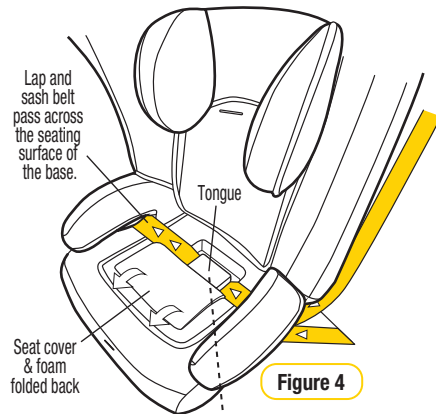

INSTALLATION

CHILD
WITH INBUILT HARNESS

INSTALLING IN VEHICLE (Using Lap-sash Seat Belt)

Step 6: Push down on the base of the restraint (with knee or hand) whilst pulling the sash section of the vehicle belt firmly up in direction of the yellow arrow in figure 5. This will make the lap belt very tight across the seat base. Whilst continuing to pull the sash section up (i.e. maintaining tightness of the lap section) attach the **Safe Grip** (red belt clamp) on the sash section as close as possible above the buckle tongue. (Refer to Figure 8 and instruction for installing the **Safe Grip** red belt clamp below) Tighten sash section of belt across the base. Place layer of foam and seat cover back into position over the top of the vehicle belt.

SAFE GRIP BELT CLAMP

The **Safe Grip** (red belt clamp) locks the lap belt to ensure a firm installation, and avoids slack in the lap belt.

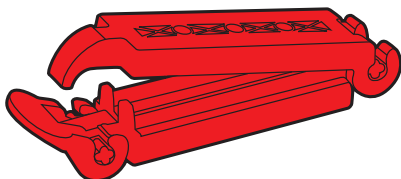

To install the **Safe Grip** (red belt clamp), open it and clamp the “sash section” of the vehicle seat belt by closing the barrel section of the red belt clamp in the direction of arrow 1 in figure 8 and then locking with the toggle section by pushing in the direction of arrow 2 in figure 8 when the **Safe Grip** (red belt clamp) is secured in place, the lap section is now tightly holding your child restraint in place, independent of the sash section. The **Safe Grip** (red belt clamp) must be removed when the child restraint is not installed to allow other users to use the seat belt as a lap/sash seat belt. Always keep the **Safe Grip** (red belt clamp) in pocket provided when not in use.

(Using Lap Seat Belt)

Step 1: Follow the instructions covered by “Installing in Vehicle (Using lap sash seat belt)” Steps 1 to 6 (refer pages 11 & 12).

Note: Do not use the Safe Grip (Red belt clamp) as there is no sash section of the seat belt.

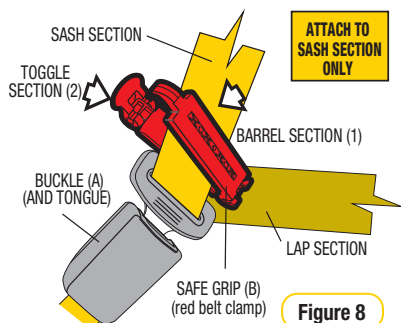
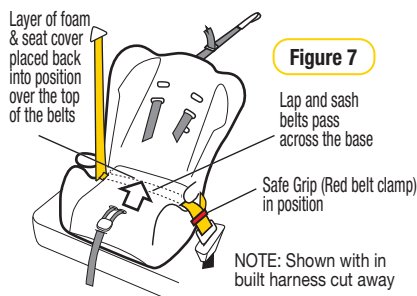
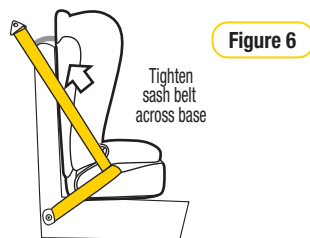
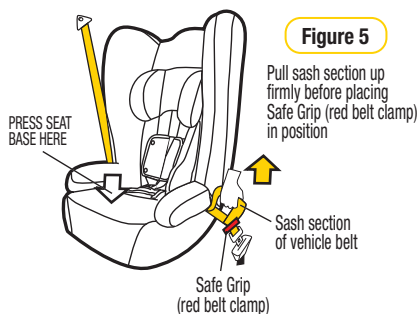

USING IN-BUILT HARNESS

- Step 1:** Ensure the restraint has been installed and set up as per “Set Up” and “Installation” (Refer page 10 - 13)
- Step 2:** “LIFT” the harness adjuster (A) to lengthen the harness (see figure 1) whilst grasping both shoulder harness straps and pulling. Ensure shoulder straps are pulled equally on each side.
- Step 3:** Place child in car seat with legs either side of the crotch strap, place harness over the shoulders and hips and engage the two buckle tongues “CLICK” into buckle. Check it is properly engaged. Ensure child is placed centrally in the seat.
- Step 4:** Pull harness adjuster strap (B) to take the slack out of the shoulder straps (see figure 2), until it is a firm but comfortable fit. Ensure buckle is adjusted centrally in relation to the child. Adjust if necessary.

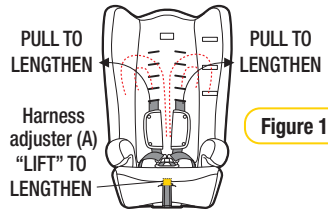

Figure 1

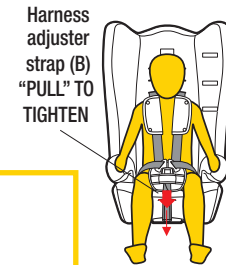

Figure 2



WARNING

- DO NOT LEAVE CHILDREN UNATTENDED IN THE CAR.
- Fit the harness firmly to the child.
- A LOOSE RESTRAINT OR HARNESS IS DANGEROUS.

TO RELEASE CHILD

- Step 1:** To release your child from the restraint simply press the belt buckle and lift the shoulder straps from the child's shoulders and carefully remove your child from the seat. It is not necessary to release the **Safe Grip** (red belt clamp), to remove your child.

Note: When the restraint is not in use, the seat belt should be fastened around it and engaged.

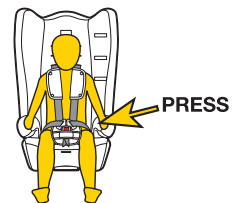

WARNING

- Always use a lap or lap-sash seat belt and upper anchorage strap to attach the child restraint to the vehicle.
- Do not use the restraint without the upper anchorage strap correctly attached and adjusted.
- Do not use on any vehicle seat which faces sideways or rearwards.
- IF AN AIRBAG IS FITTED IN THE SEATING POSITION WHERE THE CHILD RESTRAINT IS TO BE FITTED, FOLLOW THE VEHICLE MANUFACTURER'S WARNINGS AND INSTRUCTIONS.

BOOSTER SEAT

(Forward Facing - using lap-sash seat belt)

BOOSTER
WITH LAP-SASH SEAT BELT

INFORMATION & WARNINGS

To be used with a lap-sash seat belt until the child's shoulders reach the upper shoulder height marker (approximately 6 to 8 years of age)

Continue to use this child restraint until the child reaches this limit. Children are safest in a booster seat until their shoulders reach the upper shoulder height marker of the booster seat. Do not use this restraint until child's shoulders are above the lower shoulder height marker. Just using a seat belt is not recommended for children that have outgrown this seat. Use a larger booster seat.

THIS RESTRAINT MUST BE USED IN CARS WITH FORWARD-FACING SEATS WITH A LAP-SASH SEAT BELT.

THIS BOOSTER SEAT IS NOT SUITABLE FOR USE WITH A CHILD HARNESS.



WARNING

- Use the restraint exactly as shown in the instructions.
- Supervision of children is needed because they may be able to undo buckles.
- DO NOT LEAVE CHILDREN UNATTENDED IN THE CAR.
- Do not alter or modify this restraint.
- Repairs must only be done by the manufacturer or agent.
- Do not allow the restraint to come into contact with polishes, oils, bleach and other chemicals.
- Destroy the restraint if it has been in a severe crash, even if no damage is visible.
- THIS RESTRAINT IS NOT SUITABLE FOR USE WHERE THE ANCHORAGE STRAP MAY FALL INTO A SPLIT IN THE SEAT BACK. (EG HATCHBACK OR WAGON)
- THIS RESTRAINT MUST BE ATTACHED TO A CHILD RESTRAINT ANCHORAGE POINT IN THE CAR. REFER TO CAR OWNER'S HANDBOOK FOR LOCATION OF ANCHORAGE POINTS. REFER TO A CHILD RESTRAINT FITTING STATION IF NO CAR ANCHORAGE POINTS ARE IN THE MOTOR CAR.
- DO NOT USE WITH JUST A LAP BELT. You must use with a lap-sash seatbelt.
- The lap part of the seatbelt must be firmly across the thighs and the sash strap fitted diagonally across the chest and on the shoulder.
- DO NOT USE THIS RESTRAINT WITHOUT THE COVER.
- Straps may be damaged by unsecured cargo in a collision. Secure or remove hazardous cargo before using this restraint. Hatch-back or wagon: do not use the child restraint where this strap may fall into a split in the seat back. Always attach hook and remove slack.
- IF AN AIRBAG IS FITTED IN THE SEATING POSITION WHERE THE CHILD RESTRAINT IS TO BE FITTED, FOLLOW THE VEHICLE MANUFACTURER'S WARNINGS AND INSTRUCTIONS.
- When used in this mode the restraint must be used in conjunction with a lap-sash seat belt.

SHOULDER HEIGHT MARKER

WITH LAP-SASH SEAT BELT
BOOSTER

SMALLER CHILD (Using Lap-Sash Seat Belt)

Shoulder height markers are provided on this restraint for a visual indication that the child is safe to travel in this restraint.
Shoulder height markers may be hidden under a pillow in the lowest position.

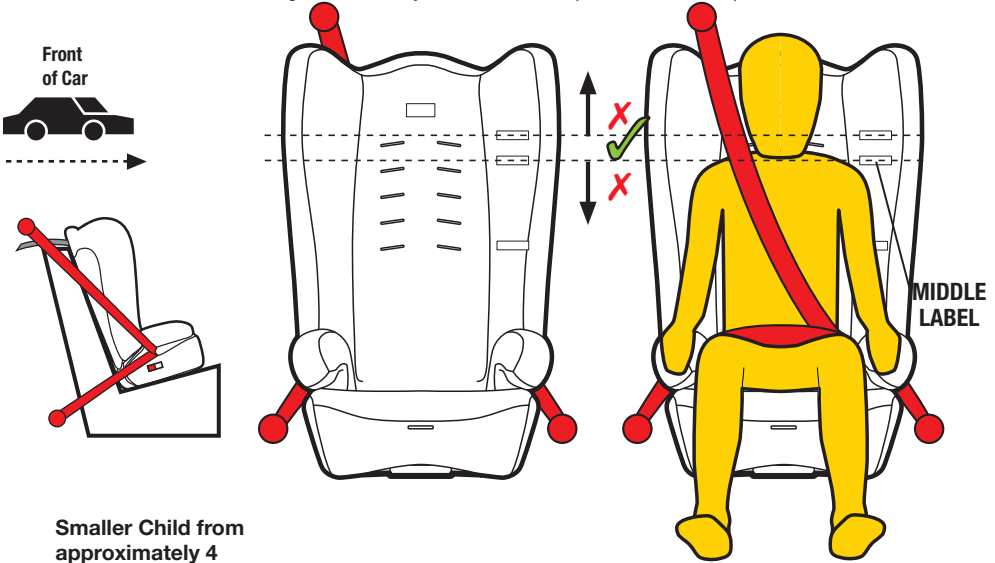

Smaller Child from approximately 4 years of age

Do not use as a booster seat until the child's shoulders are above the middle shoulder height marker (middle label).

MIDDLE LABEL (Forward Facing)

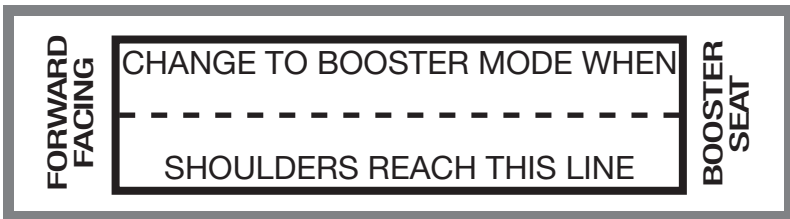

! IMPORTANT

When the child's shoulders reach the shoulder height marker (Middle Label), convert the child restraint to booster seat mode and use with a lap sash seat belt.

If moving a child from forward-facing child restraint, to a booster child restraint the child's shoulders will need to be in-line or above the middle label. If the child's shoulders are below the middle label, then the child should remain forward-facing.

SHOULDER HEIGHT MARKER

BOOSTER
WITH LAP-SASH SEAT BELT

TALLER CHILD (Using Lap-Sash Seat Belt)

Shoulder height markers may be hidden under a pillow in the lowest position

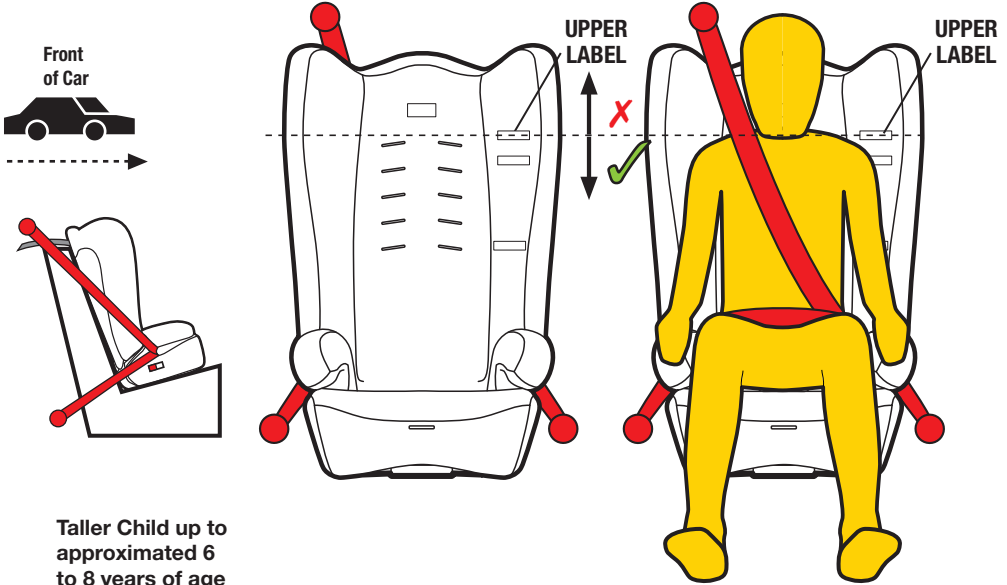

Continue to use this booster child restraint until the child's shoulders reach the upper shoulder height marker, (Upper Label)

UPPER LABEL (Forward Facing)

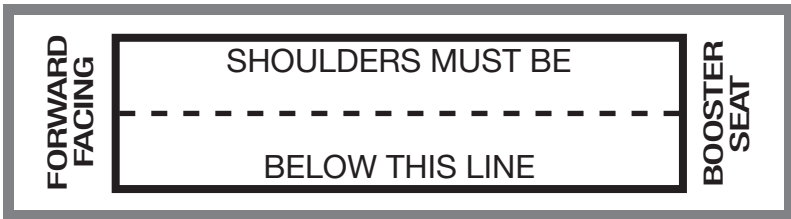

Children are safest in a booster seat until their shoulders reach the upper shoulder height marker of the booster seat.

If the child's shoulders reach the upper shoulder height marker (Upper Label), the child should move to the next type of restraint (see page 5).

Just using a seat belt is not recommended for children that have outgrown this seat, use a larger booster seat.

CS7110/CS7210

WITH LAP-SASH SEAT BELT
BOOSTER

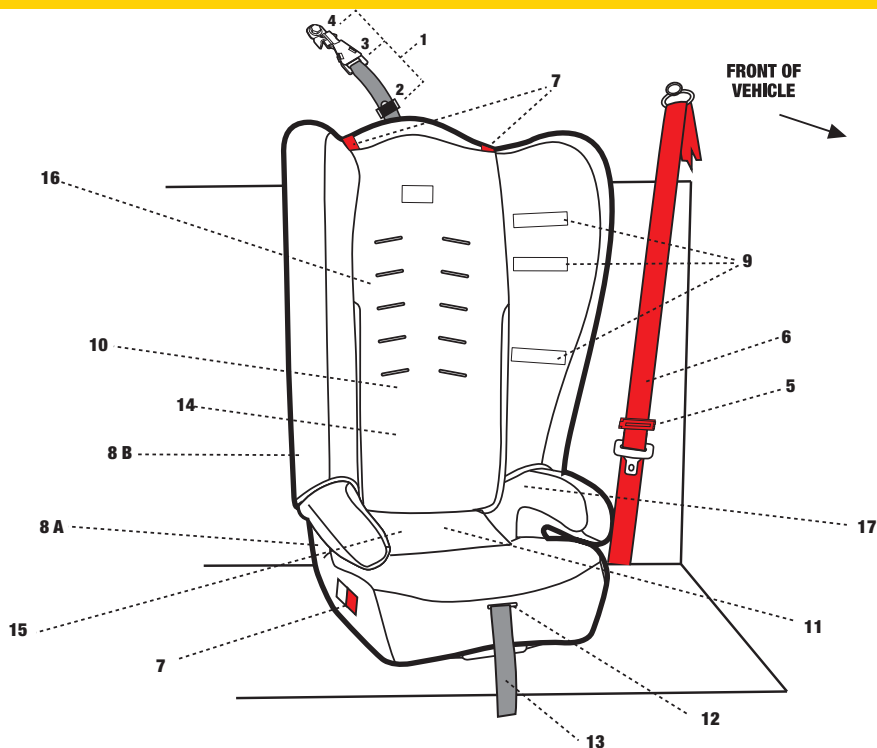

- | | |
|---|---|
| 1. UPPER ANCHORAGE STRAP ASSEMBLY | 8. COMFORT COVER
A - SEAT BASE
B - BACKREST |
| 2. UPPER ANCHORAGE STRAP ADJUSTER | 9. SHOULDER HEIGHT MARKER |
| 3. ATTACHMENT CLIP | |
| 4. ANCHOR FITTING + ATTACHMENT HARDWARE | |
| 5. SAFE GRIP RED BELT CLAMP (SUPPLIED IN POCKET) | |
| 6. VEHICLE SEAT BELT | |
| 7. "BOOSTER SEAT BELT PATH" MARKER
(EACH SIDE OF RESTRAINT - COLOURED RED) | |

IMPORTANT

For a vehicle without a fixed parcel shelf an extension strap(s) may be needed.
If so ring (02) 4728 8080 for nearest supply location. (Refer page 13)

Seat belt extenders should not be used if the seat belt is not long enough to secure the child restraint.

SET UP

BOOSTER
WITH LAP-SASH SEAT BELT

SELECTION OF APPROPRIATE PADDING COMBINATIONS

Step 1: Determine whether your child requires the additional padding provided with this restraint, to ensure a safe and snug fit in the restraint. Refer to page 10 for suggested padding combinations.

CONVERTING TO A CHILD BOOSTER

IMPORTANT

FOR USE OF THIS RESTRAINT AS A BOOSTER SEAT THE HARNESS MUST BE STORED BEHIND THE COVER. FOLLOWING STEPS EXPLAIN HOW THIS IS TO BE DONE.

Step 1: Disengage the buckle, undo the cover flap located between the leg straps, remove buckle pad and place the buckle in the recessed section of the plastic base. Close the flap in the cover (refer to in Figure 1 & 2).

Step 2: Disengage shoulder straps from "G" connecting plate as shown on page 12 (refer to section "Shoulder Slot Height" - Step 1 & 2). Remove and store Shoulder Pads & Buckle Pad. Lift the front flap of the seat cover (see Figure 3).

Step 3: UNDER FLAP
Thread the harness strap back through the top shoulder slots and reconnect the "G" plate as per page 12 (refer to section "Shoulder Slot Height" - Step 3 & 4).
Tightening the harness with harness adjuster strap located at the front of the seat.
Place the two buckle tongues in the recess in the plastic base at point (A) in Figure 3.
Resecure front flap of seat cover.

Step 4: Select the appropriate shoulder slots that are above the child's shoulder (refer page 17 & 18). Attach the sash guide through the shoulder slots, pass the sash guide through the slots so that it is positioned at the front of the restraint.

The restraint is now ready as a booster seat.

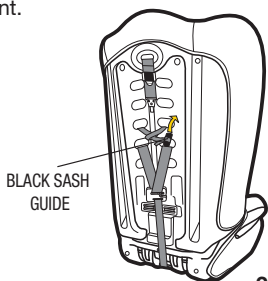

Figure 4

REAR VIEW SHOWN WITHOUT HARNESS AND OR UPPER ANCHORAGE

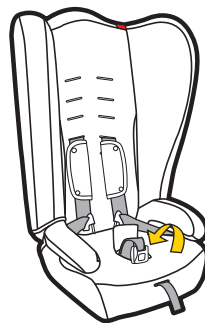

Figure 1

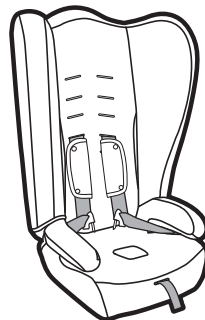

Figure 2

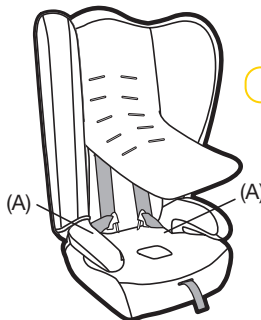

Figure 3

INSTALLATION

ADJUSTING RECLINE ANGLE

Determine which angle is preferred for the comfort of your child.

TO RECLINE

Pull down the recline base and ensure the support is forward (in position).

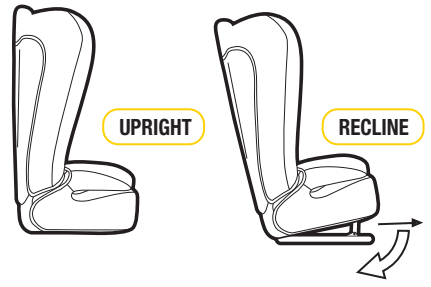

INSTALLING IN VEHICLE

- Step 1:** Place the child restraint in the car, in a forward facing seating position (Refer to Figure 1)
- Step 2:** Install the upper anchorage fitting as shown on page 3 & 4 of these instructions
- Step 3:** Hook the attachment clip to the anchor fitting. Ensure there are no twists in the upper anchorage strap (Refer to Figure 2)
- Step 4:** Pull to tighten to remove all the slack, from the upper anchorage strap. (Refer to Figure 2) Do not overtighten as this could cause the restraint to lift off the vehicle seat.

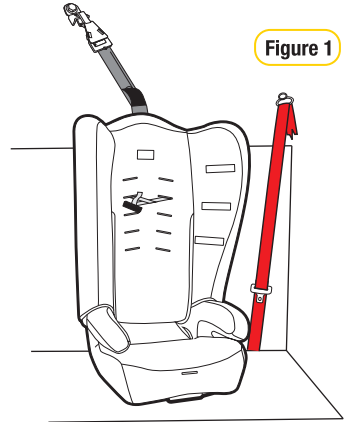

Figure 1

WARNING

- Always use upper anchorage strap to attach the child restraint to the vehicle.
- Do not use the restraint without the upper anchorage strap correctly attached and adjusted.
- Do not use on any vehicle seat which faces sideways or rearwards.
- IF AN AIRBAG IS FITTED IN THE SEATING POSITION WHERE THE CHILD RESTRAINT IS TO BE FITTED, FOLLOW THE VEHICLE MANUFACTURER'S WARNINGS AND INSTRUCTIONS.
- Fit the restraint firmly to the car seat.

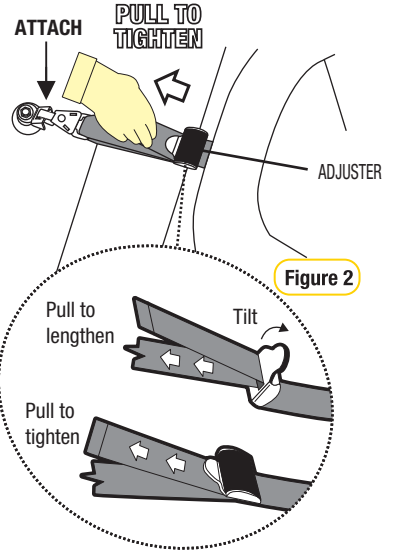

Figure 2

USING LAP-SASH SEAT BELT

**WARNING**

- **DO NOT USE WITH JUST A LAP BELT.**
You must use a lap-sash seat belt.

- Step 1:** Ensure the restraint has been installed as per “INSTALLING IN VEHICLE” (refer page 20).
- Step 2:** Sit your child in the restraint with their back against the backrest.
- Step 3:** Position the lap section of the vehicle seat across the child’s lap then insert the buckle tongue in the belt buckle (A). Ensuring the lap portion is positioned under the armrests and over the child’s thighs.

**IMPORTANT**

Ensure that you use the **BOOSTER SEAT BELT PATH** indicators, marked in “red”.

The red “Booster Seat belt Path” labels are located each side of the Booster seat and at the head of the Booster seat (as shown on page 19).

- Step 4:** Pull the lap belt tight by first pulling on the lap belt in the direction of arrow 1 (refer Figure 1). Pull the sash belt tight in the direction of arrow 2 while holding the belts tight, place the Safe Grip (red belt clamp) (B) on the sash section as close as possible to the buckle tongue (A). (Refer to Figure 2 and instruction for installing the **Safe Grip** red belt clamp below).

Figure 1

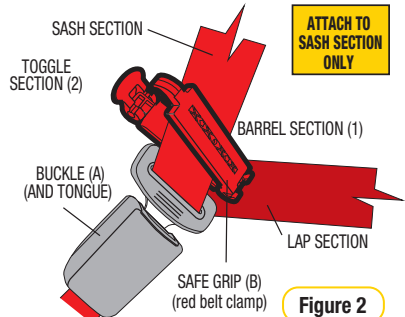
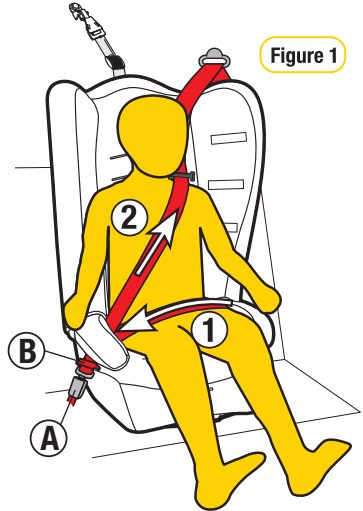
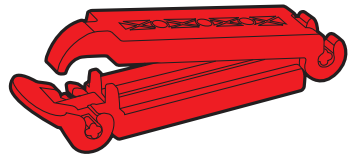

Figure 2

SAFE GRIP BELT CLAMP

It is important that the lap belt must be **firmly across the thighs**. The **Safe Grip** locks the lap belt to ensure a firm fit across the thighs, and avoids slack in the lap belt. This fit ensures that the lap belt **does not ride up** into the soft abdominal region of the child, which may cause internal injury.

To install the **Safe Grip** (red belt clamp), open it and clamp the “sash section” of the vehicle seat belt by closing the barrel section of the red belt clamp in the direction of arrow 1 in Figure 2 and then locking with the toggle section by pushing in the direction of arrow 2 in Figure 2 when the **Safe Grip** (red belt clamp) is secured in place, the lap section is now tightly holding your child in place, independent of the sash section. The **Safe Grip** (red belt clamp) must be removed when the child restraint is not installed to allow other users to use the seat belt as a lap/sash seat belt. Always keep the **Safe Grip** (red belt clamp) in pocket provided when not in use.



USING LAP-SASH SEAT BELT

**WARNING**

- DO NOT LEAVE CHILDREN UNATTENDED IN THE CAR.
- Fit the seat belt firmly to the child.
- A LOOSE RESTRAINT OR HARNESS IS DANGEROUS.

Step 6: Pass the shoulder belt through the belt sash guide (refer Figure 3) which is fastened to the restraint by a webbing strap. Adjust the position so that the shoulder belt lies comfortably over the child's shoulder (Refer Figure 4). Adjust to the required length.

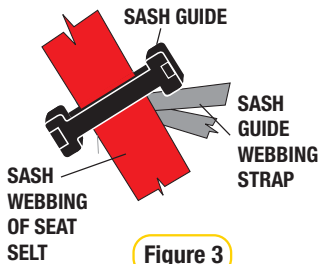
**IMPORTANT**

Always use this sash guide

SAFETY WARNING

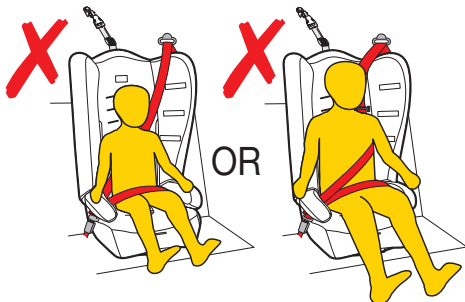
**WARNING**

A sash belt under the arm or behind the back is dangerous

USE

TO RELEASE CHILD

Step 1: To release your child from the restraint simply press the belt buckle carefully remove your child from the seat. It is not necessary to release the red belt clamp, to remove your child

Note: When the restraint is not in use, the seat belt should be fastened around it and engaged.



WARNING

- Always use lap-sash seat belt and upper anchorage strap to attach the child restraint to the vehicle.
- Do not use the restraint without the upper anchorage strap correctly attached and adjusted.
- Do not use on any vehicle seat which faces sideways or rearwards.
- IF AN AIRBAG IS FITTED IN THE SEATING POSITION WHERE THE CHILD RESTRAINT IS TO BE FITTED, FOLLOW THE VEHICLE MANUFACTURER'S WARNINGS AND INSTRUCTIONS.
- DO NOT USE WITH JUST A LAP BELT. You must use with a lap-sash seat belt
- Ensure the lap belt is correctly positioned on the child's thighs and hips.
- Do not place the seat belt sash under the arm or behind the back of the child.

CARE OF RESTRAINT

The child restraint cover has been manufactured to meet the Australian Standards requirements for flammability and toxicity to ensure your child's safety. The cover has also been designed to provide your child with comfort and support.

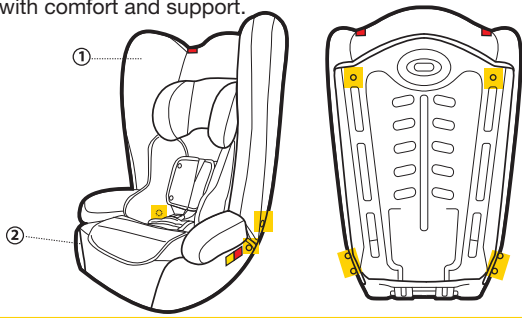

1. BACKREST
2. BASE COVER



VERY IMPORTANT

Only use this child restraint with the cover supplied or a manufacturer-Authorised replacement cover with identical shoulder height markers

CARE OF RESTRAINT

TO REMOVE HARNESS

- Step 1:** Disengage shoulder straps from “G” connecting plates as shown on page 12 (refer to section “Shoulder Slot Height” - Step 1 & 2).
- Step 2:** Disengage buckle tongues from the buckle.
- Step 3:** Pass the three bar slide located below the thigh harness slots on the end of each body/shoulder straps through the thigh harness slots. Each side of harness is now removed. (see Figure 2).
- Step 4:** To release the buckle / crotch strap pass the three bar slides attached through the crotch slot holes in seat section (see Figure 3).

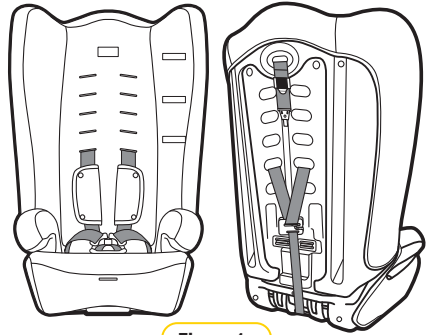

Figure 1

TO REPLACE HARNESS

- Step 1:** Connect the buckle/crotch strap by feeding the three bar slides on the crotch strap through the holes in seat section (see Figure 3).
- Step 2:** Reconnect shoulder straps to “G” connecting plate as shown on page 12 (refer to section “Shoulder Slot Height” - Step 3 & 4).
- Step 3:** Engage the buckle tongues in the buckle.
- Step 4:** Feed the lap end of the harness and the three bar slide through the thigh slots (see Figure 1 & 2).

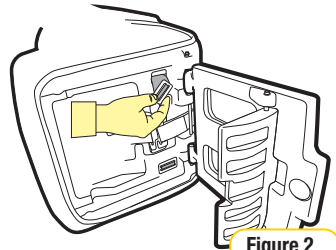

Figure 2

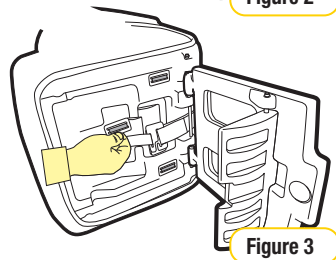

Figure 3

TO REMOVE & REPLACE COVERS

BASE COVER:

- Step 1:** Disengage buckle and tongues.
- Step 2:** Push the buckle through the crotch slot in the cover.
- Step 3:** Unclip the four press studs and remove Base Cover.

BACKREST COVER:

- Step 1:** Do Step 1 from “To Remove Harness”.
- Step 2:** Unclip the four press studs at the bottom of the cover and disconnect the two elastic loops located at the top of cover (rear).
- Step 3:** Remove Backrest Cover.

TO REPLACE COVERS REVERSE THE ABOVE PROCEDURE.

CARE OF RESTRAINT

CLEANING



IMPORTANT

Use only mild soap and water to clean all parts of the CS7110/CS7210 Booster Seat.
Do not use chemicals or cleaning agents
Cold water only to be used and to be rinsed well
Do not dry clean or tumble dry
Do not bleach.

COVERS

The restraint has a flame retardant cover which is removable for cleaning. Cleaning instructions are on the care label attached to the cover. If a fluffy cover is fitted, then washing the cover prior to use will remove excess fluff.

The cover has been designed to protect your child when seated in the restraint. Care should be taken if children either eat or drink while in the restraint as some food or drink products may cause damage or marking to the cover. Wash or clean immediately. Do not pull sticky items from covers as the cover may be damaged - soak in water and gently remove.

Only machine wash on gentle cycle (hand washing is recommended). When washing the covers, ensure the hook and loop attachment strips are connected to eliminate other materials or garments being caught. Ensure that the hook and loop attachment strips are free of lint, this will ensure a positive engagement.

SEAT

Use only mild soap and water to clean all webbing, metal and plastic parts of the restraint using a damp cloth.
Do not use chemicals or cleaning agents

CARE OF RESTRAINT

CLEANING

HARNESS BUCKLE

If sticky liquids such as baby formula, fruit juice, etc. get inside your Harness Buckle, it may become sluggish. An indication of a sluggish Harness Buckle is that you cannot hear a **“CLICK”** when engaging the Harness Tongues. To restore the Harness Buckle to good working order it needs to be cleaned as follows:

- Step 1:** From the underside of the restraint pull each crotch 3-bar slide then turn 3-bar slide and push through each slot to remove the Harness Buckle from the restraint (refer Figure 1).
- Step 2:** Place the Harness Buckle under warm (max. 40 degrees Celsius) running water as shown below. Let the water run through the mouth of the buckle for five minutes. Do not immerse the harness in water (refer Figure 2).
- Step 3:** Engage and disengage the Harness Tongues and Buckles several times until a strong audible **“CLICK”** is heard when inserting the last tongue (refer Figure 3).
- Step 4:** If you still cannot hear a strong audible click after engaging the Harness Tongues and Buckle, then repeat cleaning several times. If the Harness Buckle cannot be returned to its original working condition then contact InfaSecure Customer Service.
- Step 5:** Refit the harness buckle to the restraint with the red button facing out and feeding each 3-bar slide through appropriate slot.

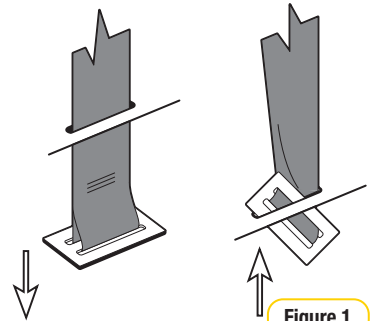

Figure 1

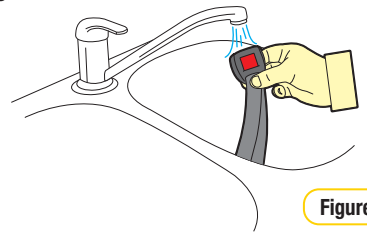

Figure 2

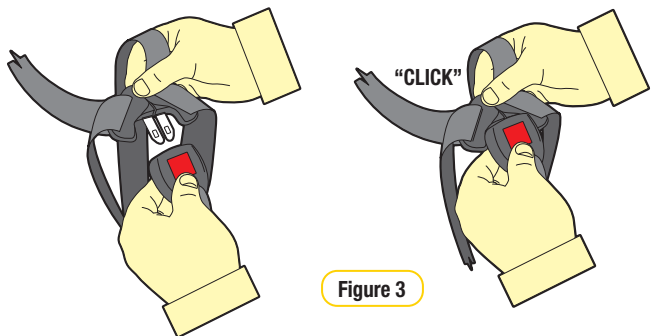

Figure 3

CARE OF RESTRAINT

CARE AND MAINTENANCE

Regular care of the restraint will ensure safety of your child.

- Check the webbing for fraying.
- Check the upper anchorage attachment clip to ensure plastic retainer clip is still present.
- Ensure there are no cracks in moulding or the plastic moulding.
- Check the buckles “click” when you engage tongues and is not sluggish or sticky in operation.
- Check the harness adjuster is operating.

EXTENSION STRAPS

If required contact InfaSecure for nearest supply location

Extension straps, not included in this package, may be required for vehicles without a fixed parcel shelf.

TYPE B & TYPE E

CHILD SEAT AND BOOSTER SEAT

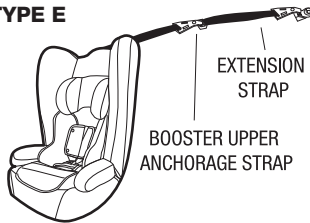

Re order Line Numbers

CS111	300mm Length
CS112	600mm Length
CS113	200mm - 900mm Adjustable Length

ACCESSORIES

HEAD PILLOW / INFANT PILLOW (if fitted)

The head pillow/infant pillow (if fitted) is designed to provide extra comfort.

- Step 1:** Position the bottom of the pillow's side wings at the top of the child's shoulders.
- Step 2:** Feed the upper and lower pillow straps through the nearest slots.
- Step 3:** Thread the strap through the plastic buckle and adjust for a firm fit.

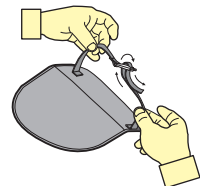
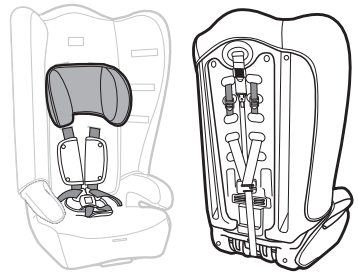

ACCESSORIES

PADDED INSERTS (if fitted)

The padded inserts are designed to add extra comfort for your child.

- Step 1:** Disengage shoulder straps from “G” connecting plate as shown on page 12 (refer to section “Shoulder Slot Height” - Step 1 & 2).
- Step 2:** Position the padded insert firmly back into the seating region of the seat.
- Step 3:** Thread the shoulder straps through the appropriate slot in the padded insert, then pass the straps through the shoulder slots in the seat.
- Step 4:** Reconnect shoulder straps to “G” connecting plate as shown on page 12 (refer to section “Shoulder Slot Height” - Step 3 & 4).
- Step 5:** Pull the buckle & leg straps through the slot or opening on the insert.

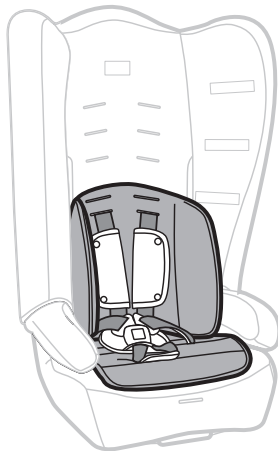

BUCKLE PAD (if fitted)

The buckle pad is designed to add extra comfort for baby or child.

- Step 1:** Position the buckle pad behind the buckle and clip in the front. The release button should be clearly visible.

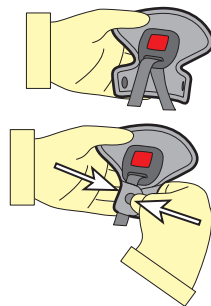

ACCESSORIES

SHOULDER PADS (if fitted)

The shoulder pad is designed to add extra comfort for baby or child.

STANDARD

- Step 1:** Separate press-studs and remove the shoulder pads from harness
- Step 2:** To attach shoulder pads, ensure press studs face away from the child and re-attach.

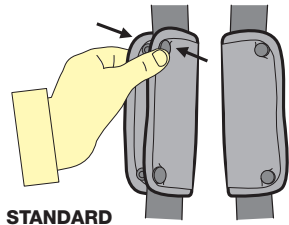

DELUXE

- Step 1:** Turn the restraint so that the back of the seat is facing you.
- Step 2:** Remove each shoulder harness through the "G" connecting plate (refer Figure 1 & 2).
- Step 3:** Pull the shoulder harness straps through the shoulder slot holes in the seat body and cover. They are now loose in the front of the seat (refer Figure 2).
- Step 4:** To attach shoulder pads, slide the shoulder pad over the harness straps (refer Figure 3).
- Step 5:** Rethread harness straps as per Steps 1 to 3 above.

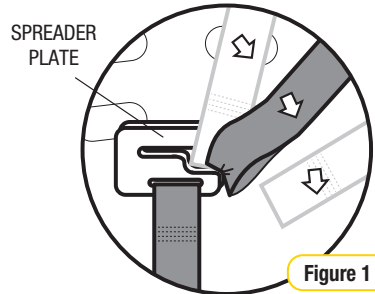

The child restraint with shoulder pads is ready to use.

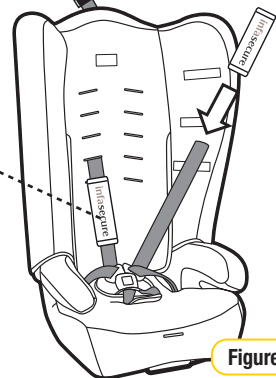
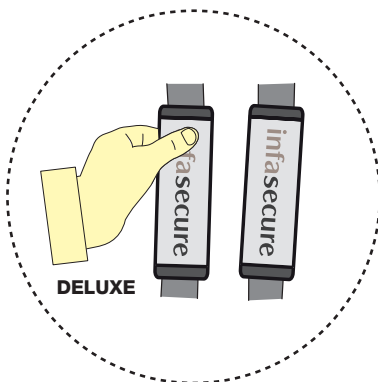
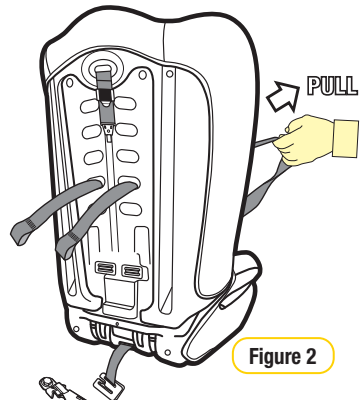

ACCESSORIES

SEAT PROTECTOR (if fitted)

The seat protector is designed to protect your car's seat.

STANDARD

Step 1: Position the front flap with pockets, at the front of the rear seat and position the mat rearwards to obtain a flat fit.

FULL LENGTH

Step 1: Position the front flap with pockets, at the front of the rear seat and position the mat rearwards to obtain a flat fit. (If required an additional flap has been provided to tuck in between the seat back & cushion)

Step 2: Position the back section up the seat back and use the plastic buckle & webbing strap to attach around the vehicle seat headrest (if the rear vehicle seat does not have a headrest then the strap could be used to attach around the child seats top tether after you have installed the child seat).

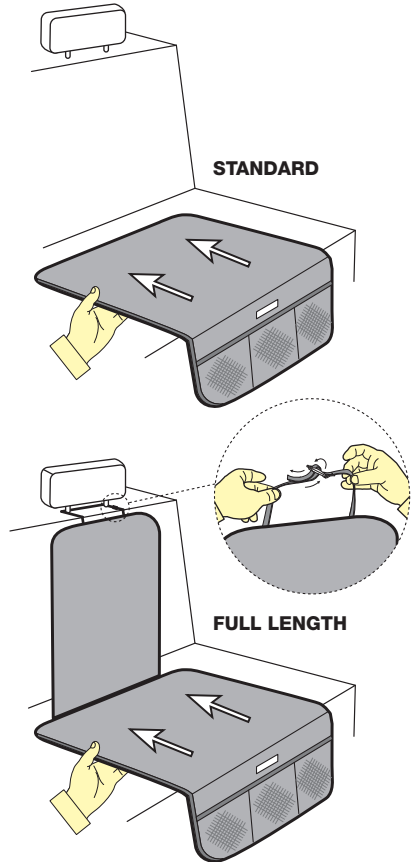

CUP HOLDER (if fitted)

Holds all standard cups/bottles.

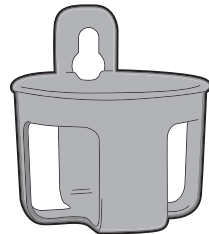

NOTES

NOTES

NOTES

Infasecure Warranty Details

Infasecure Pty Ltd warrants this product for twelve months from the date of purchase against failure due to manufacturing faults or faulty materials. Misuse, accidental damages, normal wear and tear are not covered by this warranty.

When used for commercial use the period is limited to six months.

“Our goods come with guarantees that cannot be excluded under the Australian Consumer Law. You are entitled to a replacement or refund for a major failure and for compensation for any other reasonably foreseeable loss or damage. You are also entitled to have the goods repaired or replaced if the goods fail to be of acceptable quality and the failure does not amount to a major failure.”

Refer to website for details

www.infasecure.com.au

INFASECURE PTY LTD

ABN: 52 149 173 660

Head Office and Registered Address

110-114 Old Bathurst Rd, Emu Plains, NSW 2750

P.O. Box 487, Emu Plains, NSW 2750

Phone No: 02 4728 8080

Fax: 02 4728 8040

Customer Service

Phone No: 02 4728 8090

www.infasecure.com.au

ISSUE: B_2



infasecure

caring for the wellbeing of infants

We reserve the right to alter this product without notice.