

CHILD INFORMATION
(KEEP WITH CAR SEAT AT ALL TIMES IN CASE OF EMERGENCY)

NAME:
.....

DATE OF BIRTH (DD/MM/YYYY):
.....

ADDRESS:
.....
.....
.....

ALLERGIES/MEDICAL CONDITIONS:
.....
.....
.....

EMERGENCY CONTACT 1:

NAME:
.....

PHONE NUMBER:
.....

EMERGENCY CONTACT 2:

NAME:
.....

PHONE NUMBER:
.....



COMET INSTRUCTION MANUAL

Group 0+/1/2/3 Car Seat Instruction Manual



Group 0+/1/2/3 Car Seat (Birth to 36kg/ approx birth to 12 years)

Thank you for purchasing this Group 0+/1/2/3 car seat. If you are not completely satisfied with the car seat or you would like to change any accessory or obtain any help about the car seat, you can contact our customer services department.

Storage of the User Guide

It is most important that these instructions remain with the car seat at all times.

You can store these instructions in the manual pocket on the back of the seat.

Please read this instruction manual carefully before use.

Contents

1. Vital information-READ NOW.....	3-4
2. Safety instructions.....	5
3. Using the child car seat in this way.....	5
4. Parts and interior equipment.....	6
5. Scope of use for children.....	7
6. Height adjustment for head support and shoulder harness.....	8
7. Using the buckle.....	9
8. Unlocking the ISOFIX.....	9
9. Adjusting the harness.....	10
10. Adjusting the backrest angle.....	10
11. Instructions for seat rotation.....	11
12. How to use the ISOFIX guides.....	12
13. Instructions for using the insert cushion.....	12
14. Installation of the child seat group 0+/1.....	13-17
15. Installation of the child seat group 1.....	18-21
16. Installation of the child seat group 2/3.....	21-26
17. Removing the covers.....	27-29
18. Maintenance and cleaning.....	30

DIRECTION	GROUP	METHOD OF INSTALLATION	TYPE
Rearward	0+/1	IS OFIX+ TOP TETHER	UNIVERSAL
Forward	1	IS OFIX+ TOP TETHER	UNIVERSAL
Forward	2/3	IS OFIT+ 3-point safety belt	SEMI-UNIVERSAL
Forward	2/3	3-point safety belt	UNIVERSAL

Notice regarding Universal category (Group 0+/1/2/3)

1. This is a "Universal" child restraint. It is approved to Regulation No. 44, 04 series of amendments, for general use in vehicles and it will fit most, but not all car seats.
2. A correct fit is likely if the vehicle manufacturer has declared in the vehicle handbook, that the vehicle is capable of accepting a "Universal" child restraint for this age group.
3. This child restraint has been classified as "Universal" under more stringent conditions than those which applied to earlier designs which do not carry this notice.
4. If in doubt, consult either the child restraint manufacturer or the retailer.

Notice regarding Semi-universal category (Group 2/3)

This child restraint is classified for "(Restricted/Semi-universal)" use and is suitable for fixing into the seat positions of the following cars:

CAR	FRONT	REAR
Refer to vehicle list	Outer	Centre
	Yes	Yes NO

Seat positions in other cars may also be suitable to accept this child car seat. If in doubt, consult either the child car seat manufacturer or the retailer.

Only suitable if the approved vehicles are fitted with 3 point with retractor safety-belts, approved to UN/ECE Regulation No. 16 or other equivalent standards.

Notice regarding Universal ISOFIX child restraint system (in Group 0+/1)

1. This is an ISOFIX CHILD RESTRAINT SYSTEM. It is approved to Regulation No. 44, 04 series of amendments for general use in vehicles fitted with ISOFIX anchor systems.
2. It will fit vehicles with positions approved as ISOFIX positions (as detailed in the vehicle handbook), depending on the category of the child seat and of the fixture.
3. The mass group and the ISOFIX size class for which this device is intended is:
Group 0+, D Group 1, B1

1. Vital information-READ NOW

For your child's safety, please read these instructions carefully before use and keep them for future reference. Failure to follow the instructions contained in this manual could result in serious injury to your child.

1. This child safety seat can only be used with the harness for children weighing 0 to 36kg. The harness is only suitable up to 18kg (group 0+/1:0 - 18kg ; group 1:9-18kg ; group 2/3:15-36kg).
2. This instruction manual can be retained in the instruction manual pocket of the child seat for its period of life.
3. Do not use this child safety seat in the home. It has not been designed for home use and should only be used in the car.
4. Never leave your child unattended in the child restraint system even for a short time.
5. The child car seat should be replaced when it has been subject to violent stresses in an accident.
6. This child restraint should be securely belted in the vehicle even when not in use. In a crash or sudden stop, an unsecured child safety seat may injure other occupants.
7. Always make sure that any straps holding the seat restraint to the vehicle are tight. Any straps restraining the child should be adjusted to the child's body, and check that the straps are not twisted.

8. IMPORTANT! Ensure that any lap straps are worn low down, so that the pelvis is firmly engaged.

9. Do not use any load bearing contact points other than those described in the instructions and marked on the child restraint, when in doubt, please contact the child restraint manufacturer.

10. Any luggage or other objects liable to cause injuries in the event of a collision should be properly secured.

11. The rigid items and plastic parts of a child restraint must be located and installed that they are not likely, during everyday use of the vehicle, to become trapped by a movable seat or in a door of the vehicle.

12. To prevent the risk of a fall, your child should always be fastened into the child car seat.

13. It is dangerous to make any alterations or additions to the device without the approval of the competent authority, and dangerous to not closely follow the installation instructions provided by the child restraint manufacturer.

14. This child safety seat is designed for children from 0kg to 36kg. Never overload the child safety seat with more than one child or with other loads.

15. The child restraint must not be used without the covers.

16. The seat cover should not be replaced with any covers, other than the one recommended by the manufacturer, because the cover constitutes as an integral part of the restraint performance.

17. Before you adjust any movable or adjustable parts of your child safety seat, you must remove your child from the child safety seat.

18. The child safety seat should be kept away from direct sunlight if the seat is not provided with a textile cover, otherwise it may be too hot for the child's skin.

19. Never use a second-hand product, as you can never be certain what was happened to it.

20. Notice: Do not use in any configuration that is not shown in the instructions.

21. Important! Before using the child car seat, please carefully read the vehicle manual for more information on the ISOFIX points.

2. Safety instructions

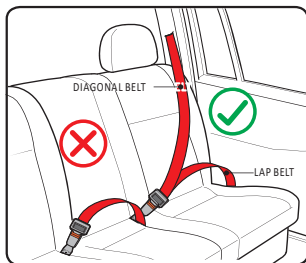

Only suitable if the approved vehicles are fitted with 3 point safety-belts, approved to UN/ECE Regulation No.16 or other equivalent standards.

3. Using safety seat in this way

Forward facing traffic direction	✓
Back facing traffic direction	✗
Vehicle is only fitted with 2-point safety belt	✗
Vehicle is fitted with 3-point safety belt	✓
Seat beside the driver	✗
Rear seat	✓
Rear middle seats Three-point Belt	✓

3.1 Please carefully implement the Country Traffic Safety Regulations

- Do not install the child safety seat at the front seat with an airbag.
- Please read the vehicle instruction manual carefully on how to use the airbag.

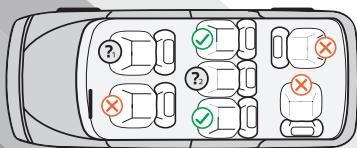



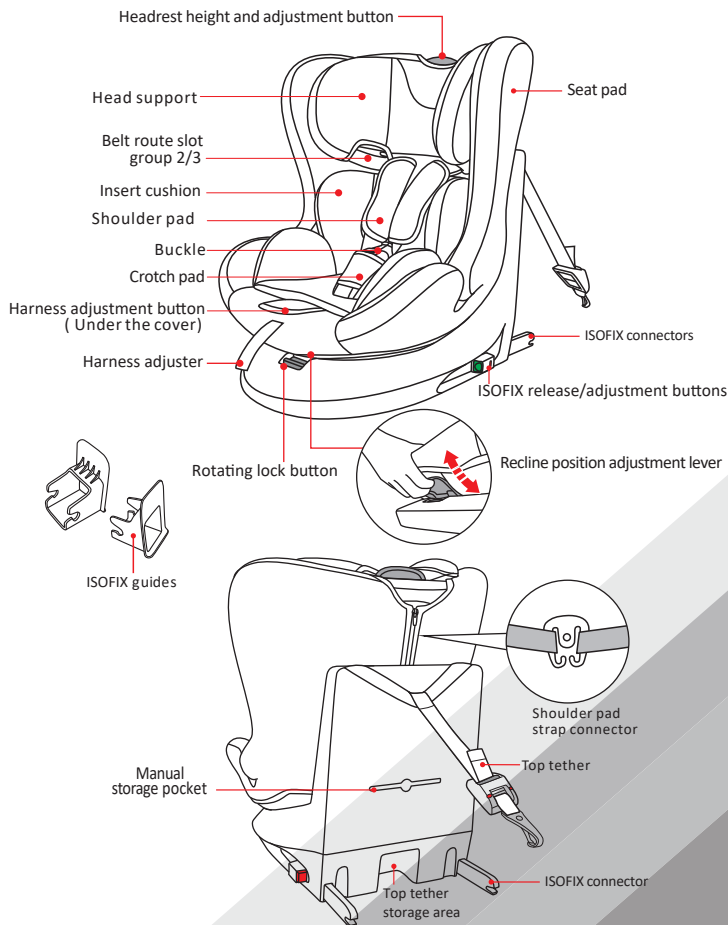

NOTICE

- ✓ You can install in this position
- ✗ You cannot install in this position.
- ? Do not install the child safety seat in the front seat with an air bag.
- ? Can only be used with the three point safety belt in this position.

4. Parts and interior equipment

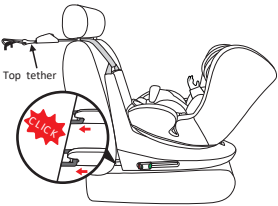

5. Scope of use for children

<p>GROUP 0+/1 (Rearward facing mode) Suitable for when the child's weight is 0 - 18kg, 0 - 4 years old (Approx.).</p>	 <p>Top tether</p> <p>Installation: ISOFIX + top tether Securing the child: 5-point harness</p>
<p>GROUP 1 (Forward facing mode) Suitable for when the child's weight is 9 - 18kg, 9 months - 4 years old (Approx.).</p>	 <p>Top tether</p> <p>Installation: ISOFIX + top tether Securing the child: 5-point harness</p>
<p>GROUP 2/3 (Forward facing mode) Suitable for when the child's weight is 15 - 36kg, 4 - 12 years old (Approx.).</p>	 <p>Installation 1: Isofix + 3-point safety belt Securing the child: 3-point safety belt</p>
	 <p>Installation 2: 3-point safety belt Securing the child: 3-point safety belt</p>

6. Height adjustment for head support and shoulder harness

Please adjust the head support and check if the shoulder harness is at the correct height for your child.

Notice: When used rear facing and forward facing, the shoulder harness height must be even with or just above the child's shoulders

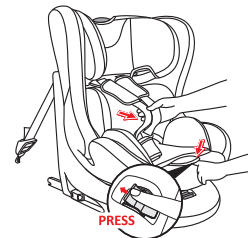
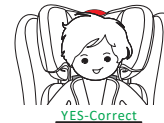

Step 1: Press the adjuster button under the cover and at the same time pull both shoulder straps forward.

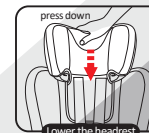
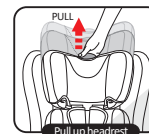
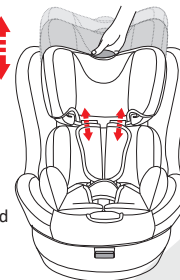

Step 2: Pull the height adjuster to adjust the height of the harness and the headrest according to the child's height.

Notice! The height for the harness is adjusted by lifting the headrest

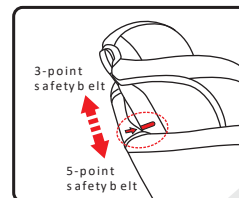

Notice: When using child car seat check the shoulder height of the child before every journey and adjust the height of the headrest.

When the height of the harness exceeds the point illustrated, the 5-point harness should be removed (Refer to figures D3 to D8 on pages 22 to 23 of the manual.) and use car seat belt to secure your child. (Refer to figures D12 to D16 on pages 25 to 26 of the manual.)

7. Using the buckle

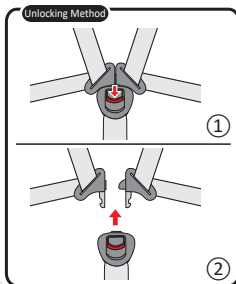
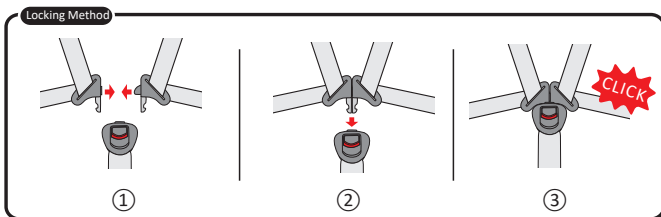

Locking Method:

Align the left and right buckle tongues to form one tongue and insert into the buckle until you hear a "Click"

Unlocking Method:

Press the red button of the buckle downwards and the two metal sections will release and pop up.

8. Unlocking ISOFIX

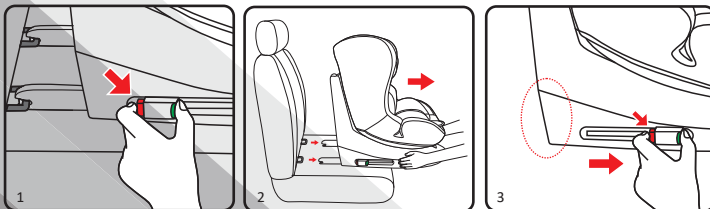

To remove from the vehicle press the ISOFIX adjuster button (fig.1) and pull the base back from the seat (fig.2).

When not connected to the vehicle's ISOFIX connectors press the ISOFIX adjuster button and move the connector completely in (fig.3) to prevent damage.

9. Adjusting the harness

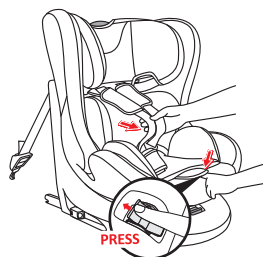

Loosening the shoulder harness:

Press the adjuster button under the cover and at the same time pull both shoulder straps forward.

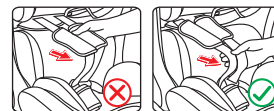

Tightening the shoulder harness
Pull the adjuster strap until the harness is fully tightened.

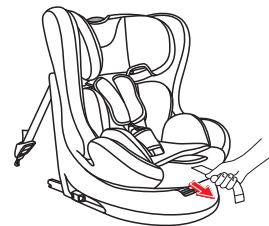

10. Adjusting the backrest angle

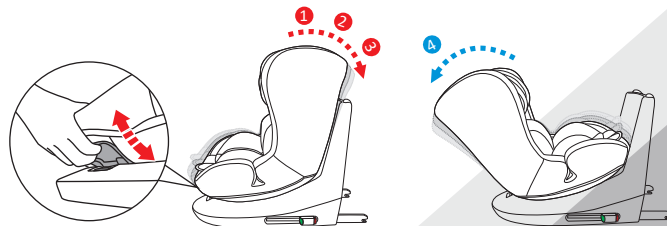

The forward and rearward installation of the safety seat has four adjustable angles. Please select the appropriate tilt angle according to the following different installation groups.

Rearward installation (group 0+/1): 4th recline position

Forward installation (group 1): 1st-3rd recline position

Forward installation (group 2/3): 1st recline position

NOTICE: When the child car seat is installed in the rearward direction, only use the 4th recline position.

How to use: Lift up the recline adjustment handle under the front of the seat, then pull it forward or push it backward. When the desired recline position is reached, release the recline adjustment handle, and finally push the seat until the "click" sound is heard.

11. Instructions for seat rotation

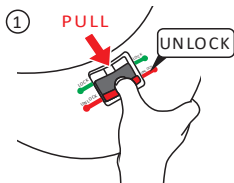

Step 1: Move the rotation lock button to the unlock position.

Step 2: Single hand rotation of the child car seat

NOTICE: Please pull the rotation lock button into the lock position again so that the child car seat is secure.

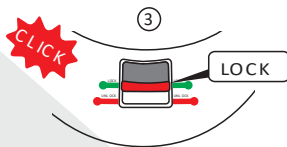
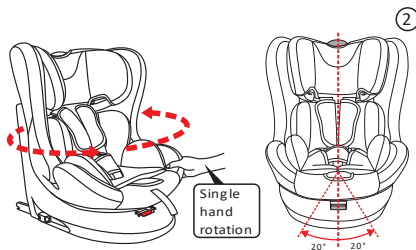

Step 3: When the "CLICK" is heard the base is locked.

NOTICE: Please make sure the seat is locked and can not rotate before driving.

WARNING: Please take care when rotating the seat as your fingers could become trapped.



⚠ WARNING

When driving, the seat should NOT be rotated to the side facing position. The side facing position will not protect the child in the event of a collision. The backrest can only be locked in position when it is forward and rearward facing and it can not be locked when side facing.

12. How to use the ISOFIX guides

In order to lock the ISOFIX connectors to the anchor points successfully, please use the ISOFIX guides.

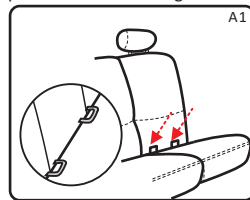

Step 1: Locate the ISOFIX anchor points in the vehicle.

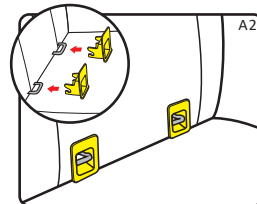

Step 2: Insert the ISOFIX guides to assist with installation

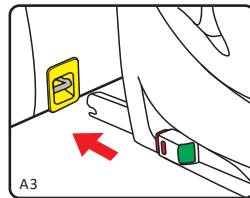

Step 3: Make sure that both ISOFIX connectors are securely attached to their ISOFIX anchor points.

Notice 1: Make sure that both ISOFIX connectors are securely attached to their ISOFIX anchor points. The indicators on both ISOFIX connectors should be completely green.

Notice 2: Check to make sure the base is securely installed by pulling on both ISOFIX connectors.

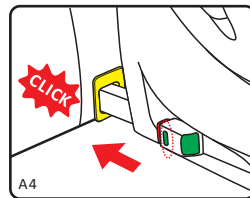

13. Using the insert cushion

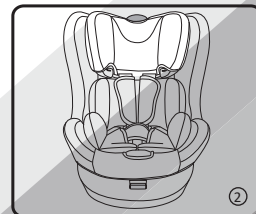
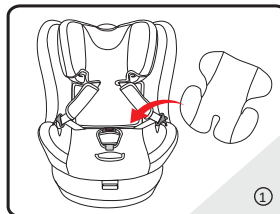

NOTICE: Please use the insert cushion when the child's weight is less than 15kgs. Put the cushion in child car seat and adjust the harness and insert cushion (fig.2).

14. Installation of the child seat group 0+/1

Suitable for when the child's weight is 0 - 18kg, 0 - 4 years old (Approx.).

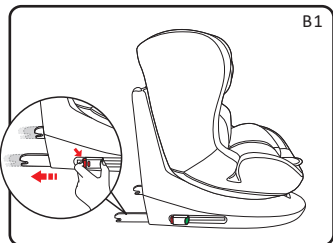

Step 1: Press the ISOFIX release/adjustment buttons to extend the ISOFIX connectors (B1).

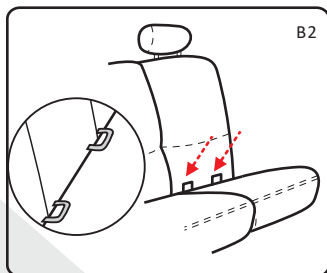

Step 2: Locate the ISOFIX anchor points in the vehicle (B2).

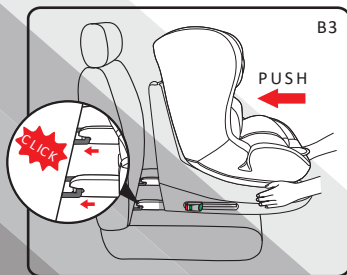

Step 3: Push the child car seat towards the vehicle seat until the ISOFIX connectors are completely locked on the anchors on the vehicle (B3).

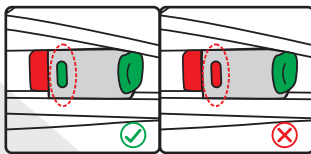

NOTICE: Ensure that both ISOFIX connectors are securely attached to their ISOFIX anchor points. The indicators on both ISOFIX connectors should be green.

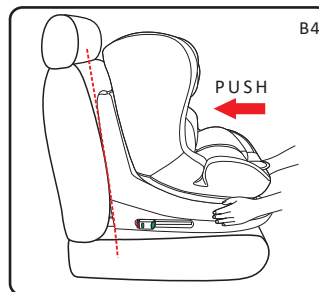

B4

Step 4: The child car seat must be firmly pushed back against the vehicle seat (B4).
Notice: The child car seat must be flush against the vehicle seat. If not this is dangerous.

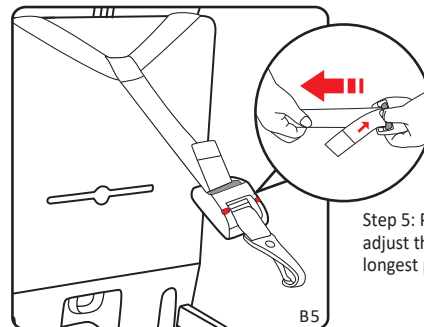
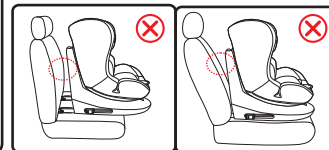

B5

Step 5: Press the adjustment button and adjust the belt of the top tether to the longest point (B5).

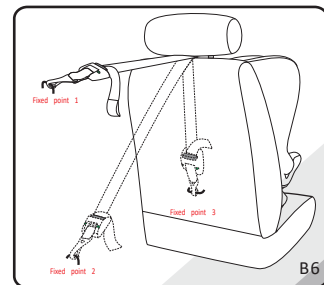

B6

Step 6: Connect top tether to the fitting point in the vehicle. Consult your vehicle handbook to help locate this (B6).



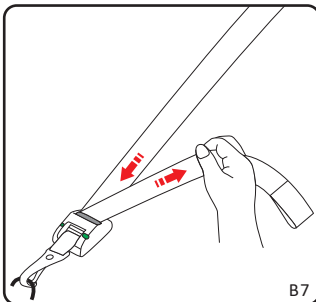

Step 7: Pull the belt of the top tether until the adjuster indicator turns green (B7). Roll up the extra belt and put away to prevent the child from playing with it. This could be dangerous if not stowed away correctly.

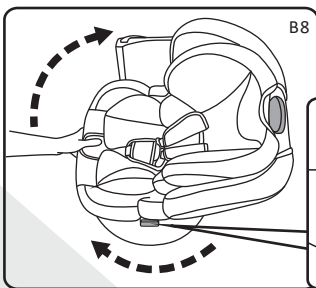
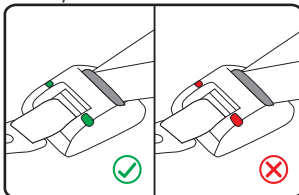

Step 8: Put the rotation lock button into the unlock position and rotate the child car seat to the side facing position (B8, B9).

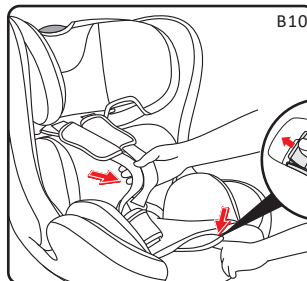
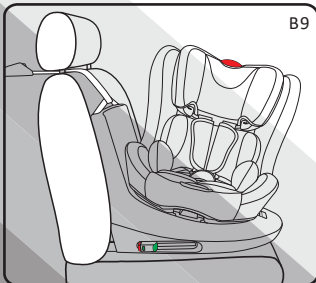

Step 9: Press the harness adjustment button, while pulling out the shoulder harness to the appropriate length (B10).

Notice: Do not pull the shoulder harness from the chest pads. Pull using the belt as illustrated (B10).

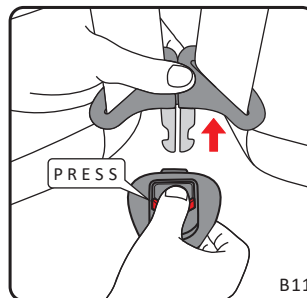

Step 10: Unlock the buckle of the harness by pressing the red button (B11).

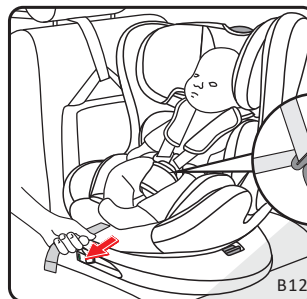

Step 11: Put the child into the seat and fasten the harness, then pull the adjuster strap until the harness is fully tightened (B12).

Notice 1: Check that the harness is not twisted.

Notice 2: Whilst driving, the seat should not be rotated to the side facing position. The side facing position will not protect the child in the event of a collision.

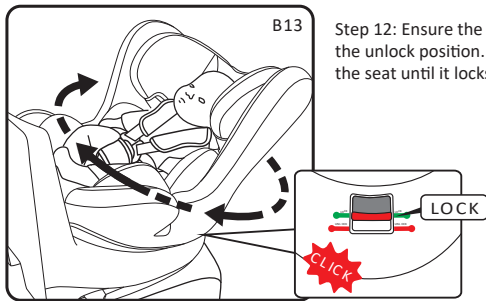

Step 12: Ensure the rotation lock button is in the unlock position. Use one hand to rotate the seat until it locks into position. (B13).

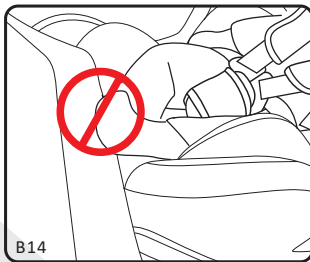

NOTICE:

1. The backrest can only be locked with the base when the car seat is forward facing and rearward facing and it can not be locked when it is turned to the side.
2. Please pull the swivel button again, when the seat cannot be rotated into place.
3. Please make sure the seat is locked and can't be rotated before driving.
4. When rotating the seat, please take care of the child's feet.

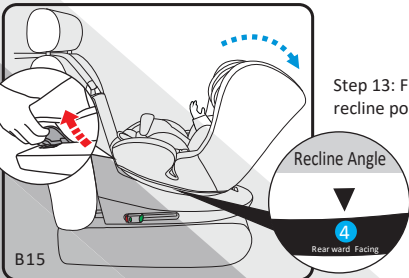

Step 13: Finally, put the child car seat into recline position 4.

NOTICE: When the safety seat is installed in rearward facing position, the recline position can be adjusted in 3 positions, but should only be used in position 4.
Important: Do not use in the forward-facing position before the child's weight exceeds 9kg.

15. Installation of the child group 1

Suitable for when the child's weight is 9 - 18kg, 9 months - 4 years old (Approx.).

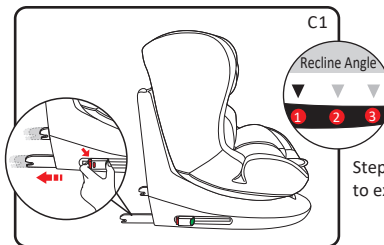

Step 1: Press the ISOFIX adjuster button to extend the ISOFIX connectors (Fig.C1)

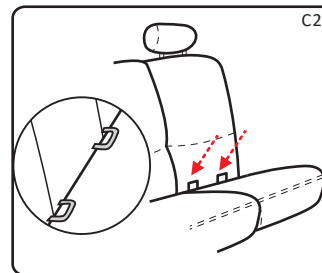

Step 2: Locate the ISOFIX anchor points in the vehicle (B2).

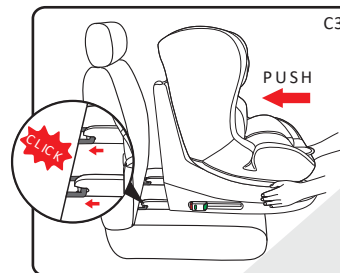

Step 3: Push the child car seat towards the vehicle seat until the ISOFIX connectors are completely locked onto the ISOFIX anchors on the vehicle (C3).

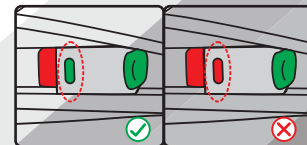

NOTICE: Ensure that both ISOFIX connectors are securely attached to their ISOFIX anchor points. The indicators on both ISOFIX connectors should be green.

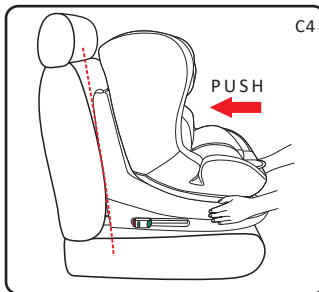

C4

Step 4: The child car seat must be firmly pushed back against the vehicle seat (C4).

Notice: The child car seat must be flush against the vehicle seat. If not this is dangerous.

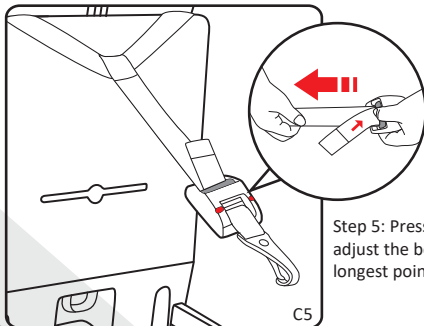
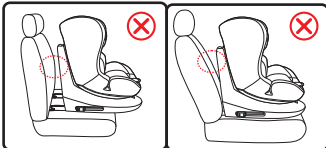

C5

Step 5: Press the adjustment button and adjust the belt of the top tether to the longest point (C5).

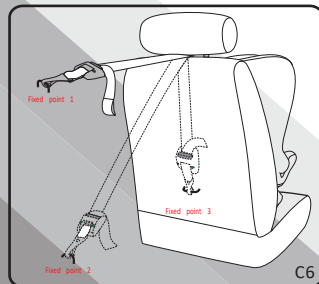

C6

Step 6: Connect top tether to the fitting point in the vehicle. Consult your vehicle handbook to help locate this (B6).



B1

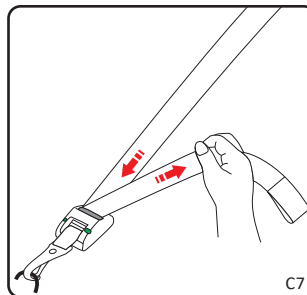

C7

Step 7: Pull the belt of the top tether until the adjuster indicator turns green (C7).

Notice: Roll up the extra belt and put away to prevent the child from playing with it. This could be dangerous if not stowed away correctly.

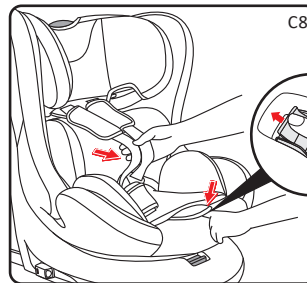
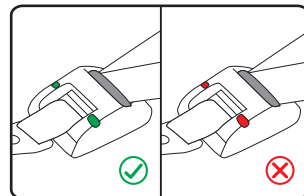

C8

Step 8: Press the harness adjustment button, while pulling out the shoulder harness to the required length (C8).

Notice: Do not pull the shoulder harness from the chest pads. Pull using the belt as illustrated (C8).

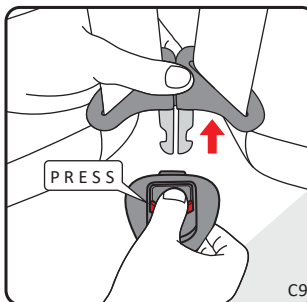

C9

Step 9: Unlock the buckle of the harness by pressing the red button (C9).

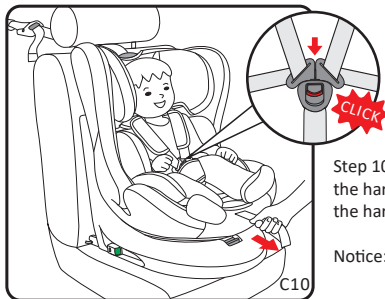

Step 10: Put the child into the seat and fasten the harness, then pull the adjuster strap until the harness is fully tightened (C10).

Notice: Check that the harness is not twisted.

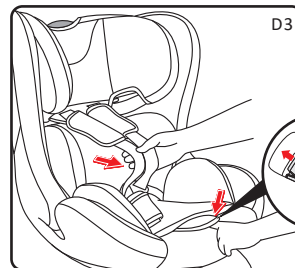

16.1 To hide 5-point harness system
Step 1: Press the harness adjustment button, while pulling out the shoulder harness to the required length (D3).

Notice: Do not pull the shoulder harness from the chest pads. Pull using the belt as illustrated (D3).

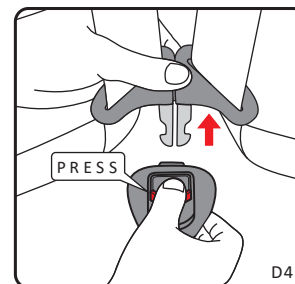

Step 2: Release the buckle (D4).

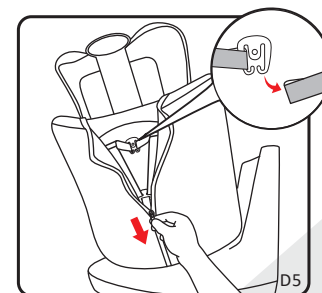

Step 3: Unzip the covers off the backrest and unhook the harness straps off the connector (D5).

16. Installation of the child seat group 2/3

Suitable for when the child's weight is 15 - 36kg, 4 - 12 years old (Approx.).

Group 2/3 installation can be fitted using ISOFIT or vehicle belt. Top tether is not required for this group fitting.

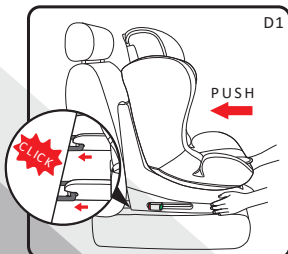

D1

1. Using ISOFIT:

Connect ISOFIT to the vehicle anchor points on the car seat (D1).

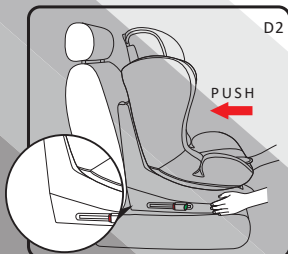
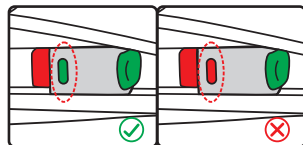

D2

2. Not using ISOFIT:

Hide the ISOFIT connectors in the base and place the car seat against the vehicle seat (D2).

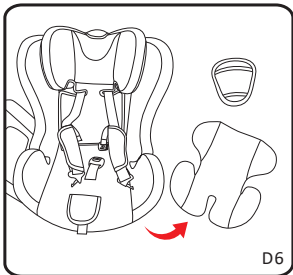

Step 4: Keep the removed cushion and accessories in a safe place (D6).

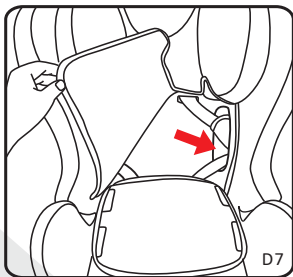

Step 5: Open the fabric cover of backrest and push the harness through the hole (D7).

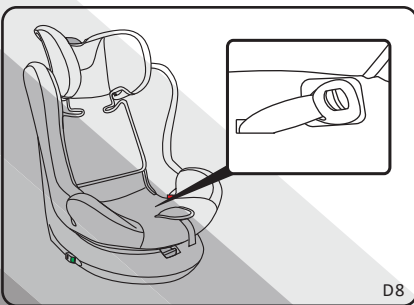

Step 6: Place the buckle in the base of the car seat (under the cover) (D8).

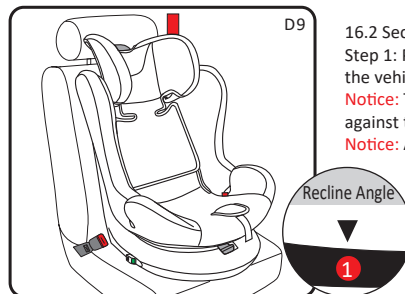

16.2 Securing the child
Step 1: Put the child car seat against the vehicle seat (D9).
Notice: The child car seat must be flush against the vehicle seat. If not this is dangerous.
Notice: Adjust the recline to position 1

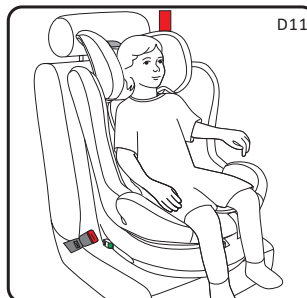
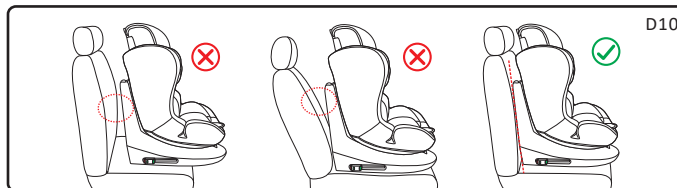

Step 2: Put the child in the seat (D11).

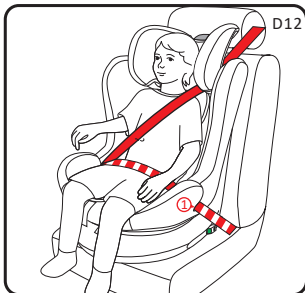

Step 3: Pull the vehicle belt out and across the child following the red guide.



Step 4: Ensure that the belt passes through the red guide (2) and then buckle in until the "Click" sound is heard.

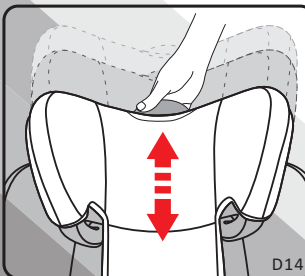

Step 5: Use the height adjuster to adjust the height of the headrest according to the child's height. The gap between head belt guide and the child is the width of two fingers. The harness straps should be level with or just above the child's shoulders (D14,D15).

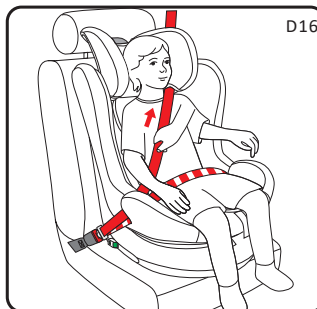
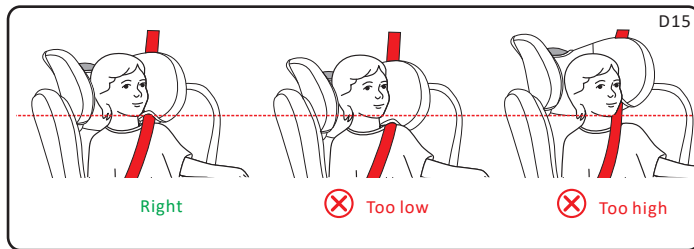

Step 4: Fasten vehicle seat belt and ensure it is tight enough (D16).

Important: Ensure that any lap straps are worn low down, so that the pelvis is firmly engaged.

17. Removing the cover

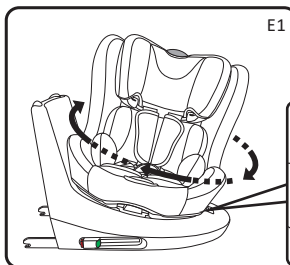

E1

Step 1: Pull the rotate button to the unlock position and rotate the child car seat to the side facing position (E1).

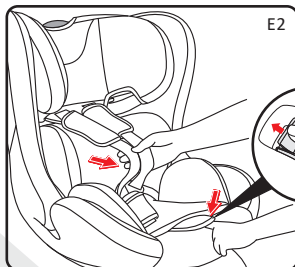
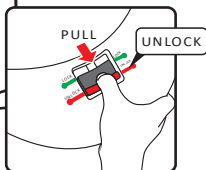

E2

Step 2: Loosen the shoulder harness (E2).

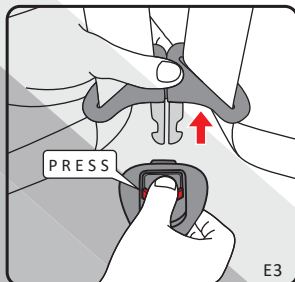

E3

Step 3: Release the buckle (E3).

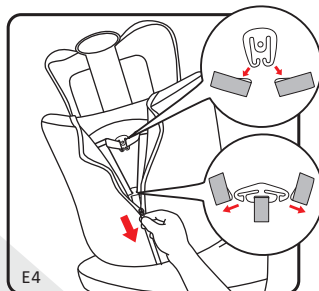

E4

Step 4: Unhook both of the harness straps off the harness connector (E4).

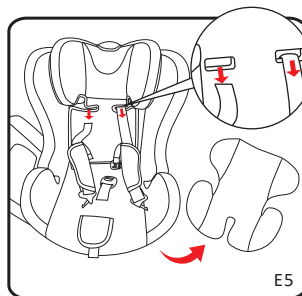

E5

Step 5: Pull out the shoulder belt, remove the insert cushion and accessories and keep in a safe place (E5, E6).



E6

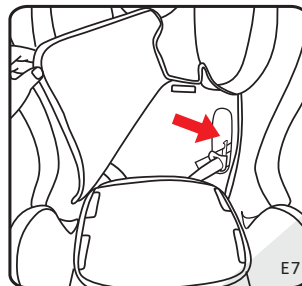

E7

Step 6: Open the fabric cover of backrest and pass the harness through the holes (E7).

18. Maintenance and cleaning

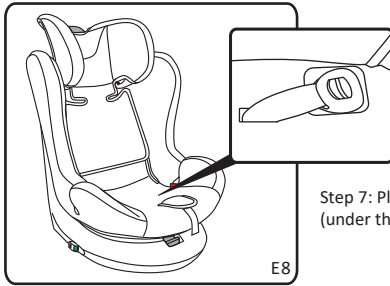

Step 7: Place the buckle in the base (under the cover) (E8).

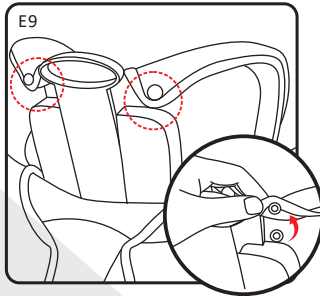

Step 8: Unlock the snap fasteners (E9).

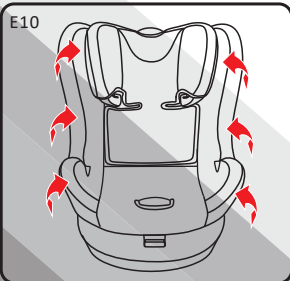

Step 9: Pull up and out to remove the covers from the seat (E10).

Follow in reverse order to put the fabric cover back on the seat.

18.1 Daily maintenance

1. Ensure that the child car seat is checked on a daily basis. The child seat should be replaced after an accident.
2. Please keep this child seat in a dry and ventilated place to avoid damp and mould.
3. If the child seat becomes dusty, clean the seat belt and the plastic pieces by wiping them with a damp sponge and allow to dry naturally.
4. Try to avoid allowing the child to eat food or drink while in the car seat. However if either is accidentally dropped on the buckle, rinse gently with warm water and leave to dry naturally.
5. For cleaning the entire child seat fabric cover, please refer to the 18.2 washing instructions.

18.2 Washing instruction

Never use any solvent, chemical detergent or lubricant on any part of your child seat. Hand wash at 30 degrees.



Hand wash,
water
temperature
below 30°C

Do not bleach

Dryclean, any
solvent except
trichloroethylene

Do not tumble dry

Do not iron